

Anti-Slip Hi-Traction® General Properties



SAFEGUARD® HI-TRACTION® & HIGLO-TRACTION® COVERS

Developed to hold up in the harshest conditions

The Safeguard Surface:

The Safeguard Anti-Slip surface is an engineered combination of epoxy, resin and fused alumina aggregate bonded to a variety of base materials in a controlled environment. These non-load bearing Covers are pre-fabricated to customer specification for retrofit installation over existing steps, walkways, and ladder rungs. When retrofit Covers are not the product of choice, customers can supply their own parts to Safeguard for direct gritting.

Products

- **Step Covers** SAFEGUARD® Hi-Traction® and HiGlo-Traction® Step Covers retrofit easily and directly over existing steps, providing slip resistance on both the stair tread and the leading edge where most slips occur. The unique “” design ensures protection precisely where it is needed.
- **Walkway Covers** Flat SAFEGUARD® Hi-Traction® and HiGlo-Traction® Walkway Covers provide antislip performance over flat flooring, walkways, sloped surfaces, ramps, and platforms.
- **Ladder Rung Covers** Both half-round and channel shaped SAFEGUARD® Covers are available for easy installation over all ladder rungs.
- **Pipe & Cable Covers** The trip hazard caused by pipes and cables can be greatly reduced with SAFEGUARD® Pipe & Cable Covers that protect the utilities underneath while removing the trip hazard that they present.

Base Material of Construction

A variety of base materials of construction are available to address your application requirements. Standard materials include: Pultruded FRP Composite, #316 Stainless Steel, G90 Hot Dipped Galvanized Steel, Flexible PVC Vinyl Sheeting, and Flexible Polymeric Geomembrane. When Covers are not an option, customer supplied parts can be shipped to Safeguard for Direct Gritting.

Sizes

SAFEGUARD® Covers are cut to customer specified sizes. Depending on the base material of construction and product shape, limitations on larger sizes do exist.

Grit - Coefficient of Friction (COF)

Safeguard incorporates fused alumina into all of its Anti-Slip products. This aggregate is characterized by hard, sharp edges creating a superior coefficient of friction that nearly doubles OSHA, ADA and APTA standards when flat or at an incline; even when wet, oily or dusty.

SAFEGUARD® Products have been tested utilizing the Mark II Model of the Brungraber as well as the English XL VIT coefficient of friction test apparatus. These are considered the most reliable and the standard for measuring COF.

Six (6) grit sizes are available to address any application; from shower areas to offshore drilling platforms in the North Sea. Super Coarse (for extreme conditions), Extra Coarse (for offshore and heavy duty use), Coarse (for industrial environments), Fine (for commercial buildings), Extra Fine (for residential steps) and Super Fine (for showers and barefoot areas).



Anti-Slip Hi-Traction® General Properties

SAFEGUARD® Hi-Traction® & HiGlo-Traction® Covers
Manufactured with pride in the U.S.A.

Colors

A variety of safety colors, standard colors, premium colors and HiGlo-Traction® colors are available to meet all of your preferences and requirements. Custom color matching is also available on a per project basis.

HiGlo-Traction®

These products incorporate a photoluminescent pigment directly into the epoxy-resin system to provide "Glow in the Dark". Unlike paints, the pigment will not wear off and will last for the life of the Cover. A light source is required to charge the product, however once the lights go out, the Covers emit a photoluminescent glow for several hours, providing an excellent Anti-Slip pathway to safety. The pigment is non-toxic, non-radioactive and can be re-charged repeatedly.

Two-Tone Configuration

Safeguard colors can be combined to provide a two-tone configuration. On Walkway Covers, contrasting color on the edges can indicate a change in profile and surface texture; contrasting color on the nosing and vertical lip of a Step Cover calls attention to the leading edge of the step and prevents optical discrepancies when descending a long stairwell. Incorporating photoluminescent into the two-tone configuration, provides an economical and safe egress solution when the lights go out.

Descriptive Messaging and Logos

Reinforce safety messaging and corporate logos by incorporating them into your SAFEGUARD® Products. Messages, PPE Symbols and Corporate Logos are directly embedded and sealed into the grit surface to ensure the message lasts for the life of the Cover. Combine the message with photoluminescent "Glow in the Dark" to provide critical direction when the lights go out.

Installation

SAFEGUARD® Covers are non-load bearing, and are pre-fabricated for quick and easy installation over existing substrates including concrete, metal, fiberglass, wood, steel & composite grating, and tile. Depending on the base material of construction and surface to be covered, mechanical fasteners, urethane adhesive, PSA (pressure sensitive adhesive) and tack-welding can be used. Pre-drilled holes are available to aid in the process.

Test Results

Results are dependent upon materials of construction. Please call for additional technical information.

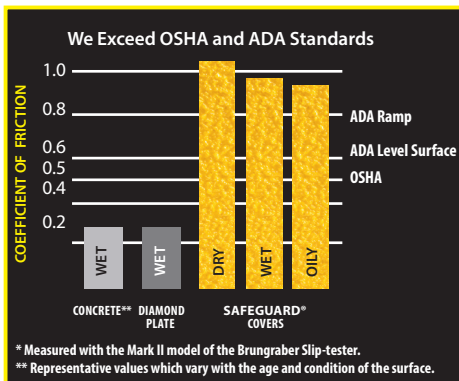

*Safeguard incorporates Fused Alumina as the aggregate in its Anti-Slip surface. This abrasive is characterized by a sharp edged particle shape and measures (9.0) on the Moh's Hardness Scale for abrasives. This ranks just below Diamond (10). Comparatively, most tapes and paints incorporate quartz or silica, which are synonyms for sand, as the aggregate. These rank only in the 6-7 range on the scale.

Average Size Of Grit (Aggregate)

Grades	Mesh	Inches	Microns	MM
Super Coarse (Xtreme) Most severe conditions	3/6	0.2	5000	5.08
Extra Coarse (Offshore) Oil platforms, heavily soiled & oily areas	10	0.085	2125	2.159
Coarse (Industrial) Most industry applications	20	0.033	850	.838
Fine (Commercial) Bus steps, commercial buildings	24	0.027	700	.686
Extra Fine (Residential) Deck steps, porches, bus steps	36	0.019	485	.483
Super Fine (Barefoot) Baths, pools and showers	54	0.012	305	.305

Average Thickness of Finished Product

Grit Coarseness	Super Coarse	Extra Coarse	Coarse	Fine	Extra Fine	Super Fine
Stainless or Galvanized Steel 18 Gauge/0.048"/1.2 mm	0.30" 7.6 mm	0.18" 4.6 mm	0.11" 2.8 mm	0.10" 2.5 mm	0.09" 2.2 mm	0.08" 2.0 mm
Pultruded FRP Composite 0.125" + 0.010 / - 0.005 3.2 mm + 0.3 mm / - 0.1	0.38" 9.7 mm	0.26" 6.6 mm	0.19" 4.8 mm	0.18" 4.6 mm	0.17" 4.3 mm	0.16" 4.1 mm
1mm Molded Fiberglass	NA	0.12" 3.15 mm	0.07" 1.8 mm	0.07" 1.7 mm	0.06" 1.5 mm	0.05" 1.3 mm
Vinyl (Flexible PVC) 0.024"/.60 mm	NA	0.15" 3.8 mm	0.08" 2.1 mm	0.07" 1.9 mm	0.06" 1.6 mm	0.05" 1.3 mm
Geomembrane Roll-Traction®	NA	NA	.101" 2.6 mm	.095" 2.4 mm	.087" 2.2 mm	.080" 2.0 mm

Materials of Construction

316 Stainless Steel	18 Gauge/0.048"/1.2 mm
G90 Hot Dipped Galvanized Steel	18 Gauge/0.048"/1.2 mm
Pultruded FRP Composite	0.125"/3.2 mm
1mm Molded Fiberglass	0.040" / 1 mm
Vinyl (Flexible PVC)	0.024"/.60 mm
Geomembrane Roll-Traction®	0.057" / 1.45 mm

Moh's Hardness Scale

Diamond	10.0
Fused Alumina Used in Safeguard Products	9.4
Quartz/Silica Sand Most Anti-Slip Products Including Tapes	6-7

Contact Safeguard Technology for more information or a free sample today.

SAFEGUARD TECHNOLOGY
Leading Manufacturer of Anti-Slip Safety Products

SAFEGUARD TECHNOLOGY INC.

330.995.5200 | 800.989.1695 Toll-Free in the U.S. and Canada
Email: info@safeguard-technology.com
www.safeguard-technology.com

© Copyright 2016 SAFEGUARD TECHNOLOGY INC.
SAFEGUARD® Covers, Hi-Traction®, HiGlo-Traction®, and Roll-Traction® are registered trademarks of SAFEGUARD Technology Inc. REV2_122115

Anti-Slip Hi-Traction® STEP COVERS

SAFEGUARD
TECHNOLOGY
Leading Manufacturer of Anti-Slip Safety Products



**Safeguard® Hi-Traction® and HiGlo-Traction®
Step Covers offer a superior alternative to temporary
paints and tapes.**

Designed with a long-lasting, aggressive gritted surface, our products are proven to provide Anti-Slip protection in a variety of environments. The "—>" shaped design wraps over the leading edge of your step to provide Anti-Slip protection where it is needed most.



www.safeguard-technology.com

Step Covers | Walkway Covers | Ladder Rung Covers | Pipe & Cable Covers | Roll-Traction® | Anti-Slip Mats | Anti-Slip Tapes

Anti-Slip Hi-Traction® STEP COVERS

SAFEGUARD® Hi-Traction® and HiGlo-Traction® Step Covers
Safely leading the way to eliminate costly slips-and-falls.

Design

Most slips occur on the leading edge of the stair step, especially when the metal, wood or concrete surface becomes worn or rounded. Water, dust, or oil on the step further accentuates the problem. SAFEGUARD® Hi-Traction® Step Covers are designed to cover the leading edge, providing excellent traction, even in adverse conditions.

Coefficient of Friction

Safeguard Technology's unique surface nearly doubles both the OSHA's 0.5 and the ADA's 0.6 guidelines for Coefficient of Friction values as confirmed in independent lab testing using the Mark II Model of the Brungraber slip tester. Even in wet or oily conditions, our Safety Covers greatly exceed these guidelines.

Choose Your Grade

We offer 6 different grades of grit, depending on your application. These include Super Coarse (for extreme conditions), Extra Coarse (for offshore and heavy duty use), Coarse (for industrial environments), Fine (for commercial buildings), Extra Fine (for residential steps) and Super Fine (for showers and barefoot areas).

Choose Your Colors

Select from a wide range of standard, premium, or custom colors. Please refer to our Standard and Premium Colors literature page.

Glow-in-the-Dark

Safeguard also offers HiGlo-Traction® Covers in photoluminescent which are visible for several hours after the light source is removed.

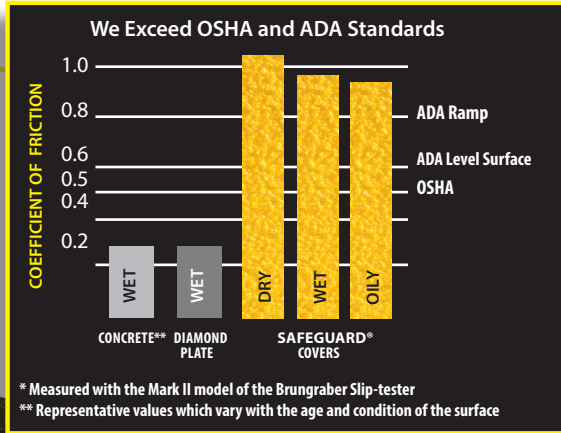

*Safeguard incorporates Fused Alumina as the aggregate in it's Antislip surface. This abrasive is characterized by a sharp edged particle shape and measures (9.0) on the Mohs' Hardness Scale for abrasives. This ranks just below Diamond (10). Comparatively, most tapes and paints incorporate quartz or silica, which are synonyms for sand, as the aggregate. These only rank in the 6-7 range on the scale.

Two-Tone Colors Add Visibility

For added safety, our two-tone step Covers call attention to the edge of the step. A contrast between the step edge and the back of the tread below provides good definition and clear visibility. For step depths greater than 3 inches, we strongly recommend using our two-tone color configuration.

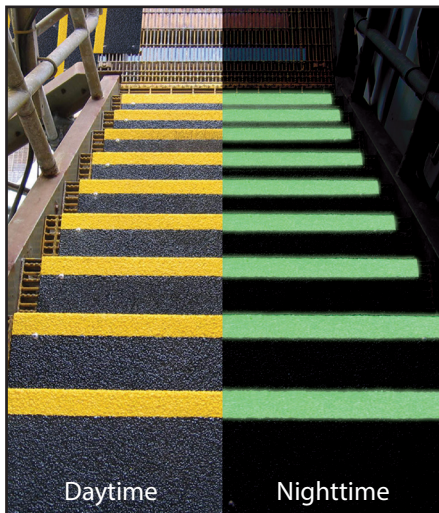

Descriptive Markings and Logos.

We can incorporate logos, Personal Protection Equipment (PPE) symbols, escape route information, and directional markings on our Covers. Our Safeguard Descriptive Marking is inlaid and will last for the life of the product.

Easy Installation and Cleaning

Safeguard® Hi-Traction® and HiGlo-Traction® Covers are not load bearing. They are prefabricated, retrofit Covers which are quickly and easily installed over existing surfaces, such as concrete, wood, metal plate and grating using mechanical fasteners, adhesive or tack welding. Installation is quick, easy and requires little to no downtime. Cleanup is easy with a non-solvent cleaner and a stiff brush. Refer to our cleaning and installation insert for complete details.

Physical Properties

Please refer to our General Properties Insert for complete physical properties and mechanical specifications.

Contact Safeguard Technology for more information or a free sample today.



SAFEGUARD TECHNOLOGY INC.

330.995.5200 | 800.989.1695 Toll-Free in the U.S. and Canada
Email: info@safeguard-technology.com
www.safeguard-technology.com

© Copyright 2016 SAFEGUARD TECHNOLOGY INC.
SAFEGUARD® Covers, Hi-Traction®, HiGlo-Traction®, and Roll-Traction® are registered trademarks of SAFEGUARD Technology Inc. REV2_122115

STEPS ONLY - Vertical lip wraps over leading edge of stairs where most slips and falls occur.

Shape Options
" — " Shape Design

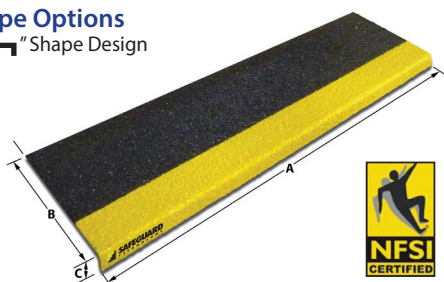

Base Materials

- 1/8" Pultruded Rigid Fiberglass
- 18 gauge (1.2mm) G90 Galvanized Steel
- 18 gauge (1.2mm) #316 Stainless Steel

Sizing (Custom sizes available)

FRP Covers

- Up to 10' in length & 15" deep
- Standard 1" vertical lip

Steel Covers

- Call for maximum capabilities

Anti-Slip Hi-Traction® Walkway Covers

SAFEGUARD
TECHNOLOGY
Leading Manufacturer of Anti-Slip Safety Products



**SAFEGUARD® Hi-Traction® and HiGlo-Traction®
Walkway Covers are ideal for flat areas requiring
Anti-Slip protection — any place you want secure
footing on a high-traffic surface!**

Designed with a long-lasting, aggressive gritted surface, SAFEGUARD® Covers offer a non-corrosive and impact-resistant, superior alternative to temporary paints and tapes.



www.safeguard-technology.com

Step Covers | Walkway Covers | Ladder Rung Covers | Pipe & Cable Covers | Roll-Traction® | Anti-Slip Mats | Anti-Slip Tapes

Anti-Slip Hi-Traction® Walkway Covers

SAFEGUARD® Hi-Traction® and HiGlo-Traction® Walkway Covers
Turn your Walkways into safe non-slip zones.

Design and Configuration

SAFEGUARD® Walkway Covers are designed specifically for flat areas and are cut to custom specifications. Covers can be configured in multiple pieces for large areas or a heel-toe-pattern to create a designated "safe walking path."



Heel-and-Toe pattern

Coefficient of Friction

Safeguard Technology's unique surface nearly doubles both the OSHA's 0.5 and the ADA's 0.6 guidelines for Coefficient of Friction values as confirmed in independent lab testing using the Mark II Model of the Brungraber slip tester. Even in wet or oily conditions, our Safety Covers greatly exceed these guidelines.

Choose Your Grade

We offer 6 different grades of grit, depending on your application. These include Super Coarse (for extreme conditions), Extra Coarse (for offshore and heavy duty use), Coarse (for industrial environments), Fine (for commercial buildings), Extra Fine (for residential steps) and Super Fine (for showers and barefoot areas).

Choose Your Colors

Select from a wide range of standard, premium, or custom colors. Please refer to our Standard and Premium Colors literature page. Custom color matching is available, please consult your Safeguard sales representative when ordering.

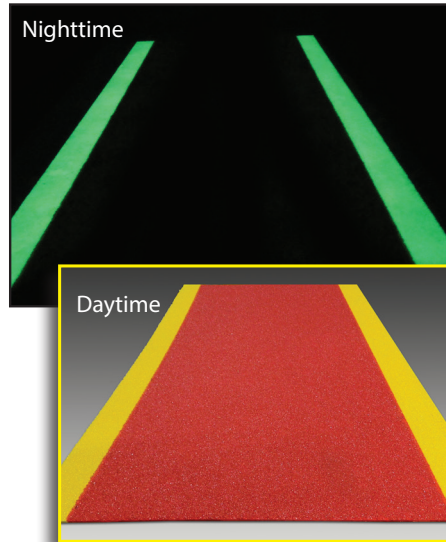

Photoluminescent edging leads the way in blackouts

Glow-in-the-dark

Safeguard also offers Hi-Glo-Traction® Covers in photoluminescent which are visible for several hours after the light source is removed.

Two-Tone Colors Add Visibility

For added safety, our two-tone configuration calls attention to the edge of the Walkway Cover providing good definition and clear visibility. Incorporate photoluminescent edging for safe egress when the lights go out.

Descriptive Markings and Logos

We can incorporate logos, Personal Protection Equipment (PPE) symbols, escape route information, and directional markings on our Covers. Our Safeguard Descriptive Marking is inlaid and will last the life of the product.



Corporate logos accentuate branding

Easy Installation and Cleaning

Safeguard® Hi-Traction® and HiGlo-Traction® Covers are not load bearing. They are prefabricated, retrofit covers which are quickly and easily installed over existing surfaces, such as concrete, wood, metal plate and grating using mechanical fasteners, adhesive or tack welding. Installation is quick, easy and requires little or no downtime. Cleanup is easy with a non-solvent cleaner and a stiff brush. Refer to our Cleaning and Installation Insert for complete details.

Physical Properties

Please refer to our General Properties Insert for complete physical properties and mechanical specifications.

Applications & Benefits

Any flat walkway surface can be a safe walking path.



Base Materials

- 1/8" Pultruded Rigid Fiberglass
- 1mm Molded Fiberglass
- Vinyl with 1PSA - Peel & Stick Installation
- 18 gauge (1.2mm) G90 Galvanized Steel
- 18 gauge (1.2mm) #316 Stainless Steel

Maximum Sizing

- 1/8" Pultruded FRP Maximum 4' x 8'
- 1mm Molded FRP Maximum 4' x 8'
- Steel Maximum 4' x 4'
- Vinyl Maximum 4' x 4'

¹ Pressure Sensitive Adhesive

Contact Safeguard Technology for more information or a free sample today.



Leading Manufacturer of Anti-Slip Safety Products

SAFEGUARD TECHNOLOGY INC.

330.995.5200 | 800.989.1695 Toll-Free in the U.S. and Canada
Email: info@safeguard-technology.com
www.safeguard-technology.com

© Copyright 2016 SAFEGUARD TECHNOLOGY INC.
SAFEGUARD® Covers, Hi-Traction®, HiGlo-Traction®, and Roll-Traction® are registered trademarks of SAFEGUARD Technology Inc. REV2_122115

Anti-Slip Hi-Traction® VINYL (Flexible PVC) WALKWAY COVERS



The Superior Alternative to Anti-Slip Tapes!

SAFEGUARD Vinyl (Flexible PVC) Walkway Covers are the lightweight, semi-flexible, "Peel-and-Stick" solution for eliminating Slips and Falls.



Anti-Slip Hi-Traction® VINYL (Flexible PVC) WALKWAY COVERS

SAFEGUARD® Hi-Traction® Vinyl Walkway Covers
Peel-and-Stick for fast Anti-Slip Protection.

SAFEGUARD Vinyl (Flexible PVC) Walkway Covers are a lightweight, semi-flexible, "Peel-and-Stick" alternative to our rigid FRP and steel based products. As with all Safeguard Covers, Vinyl Walkway Covers exhibit a superior coefficient of friction that exceeds both OSHA & ADA recommended levels.

Installation

Each Cover comes standard with an Adhesive Transfer Tape laminate and mylar film backing. Simply remove the mylar and press into place for a quick, clean installation. Vinyl Walkway Covers are available without Pressure Sensitive Adhesive (PSA); however, care must be taken to choose a proper adhesive specifically designed to bond with vinyl.



* To ensure proper adhesion, follow the detailed instructions provided in the Safeguard Installation Guide.

Sizes

Vinyl Walkways come in sheet form with a maximum size of 48" x 48" and a minimum of 4" x 4". Choose from five grades of grit, from Super Fine (Barefoot) to Extra Coarse (Offshore). Xtreme grade is not available on Safeguard Vinyl Walkway Covers.



Colors

Available in all Safeguard Standard, Premium, and Glo Colors as well as two-tone configurations.

Applications

Safeguard recommends installation over smooth surfaces such as steel, smooth concrete or painted surfaces.

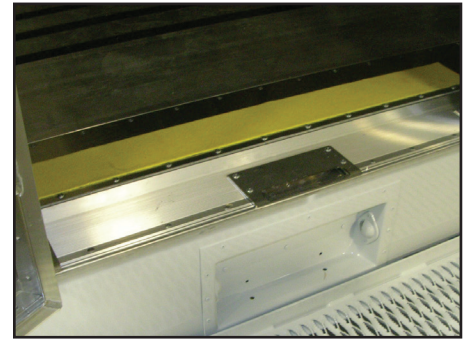

Wood is also an option however, prior testing may be necessary to ensure the chemicals in the wood do not inhibit the bond with the PSA.

The Covers are not designed for extreme angles of 90° such as steps, but have limited flexibility allowing for installation over curved surfaces such as tank tops, wheel wells or any surface that is not completely flat or have a slight radius.

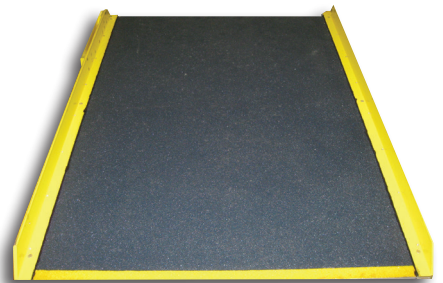

Physical Properties and Installation

Please refer to our General Properties and Installation Insert for complete guidelines and instructions.

Contact Safeguard Technology for more information or a free sample today.



SAFEGUARD TECHNOLOGY INC.

330.995.5200 | 800.989.1695 Toll-Free in the U.S. and Canada
Email: info@safeguard-technology.com
www.safeguard-technology.com

© Copyright 2016 SAFEGUARD TECHNOLOGY INC.
SAFEGUARD® Covers, Hi-Traction®, HiGlo-Traction®, and Roll-Traction® are registered trademarks of SAFEGUARD Technology Inc. REV2_122115

Average Thickness of Finished Product

Grit Coarseness	Super Coarse	Extra Coarse	Coarse	Fine	Extra Fine	Super Fine
Vinyl (Flexible PVC) 0.024"/.60mm	NA	0.15" 3.8mm	0.08" 2.1mm	0.07" 1.9mm	0.06" 1.6mm	0.05" 1.3mm

Anti-Slip Hi-Traction®
1mm FRP
WALKWAY COVERS



SAFEGUARD 1mm Fiberglass Walkway Covers provide a low profile, lighter alternative to the 1/8" base material version.

Designed for quick and easy installation with the option of pressure sensitive adhesive.



Anti-Slip Hi-Traction® 1mm FRP WALKWAY COVERS

SAFEGUARD® Hi-Traction® 1mm Walkway Covers
Thin profile alternative with peel-and-stick option.

Safeguard® 1mm Walkway Covers are designed for quick and easy installation over existing surfaces including metal, wood, and concrete. These Walkway Covers are not load bearing. Safeguard recommends using a high quality Adhesive or request PSA (Pressure Sensitive Adhesive) laminate for "Peel-and-Stick" installation. Rivets and screws can be used but care must be taken due to the thin profile.

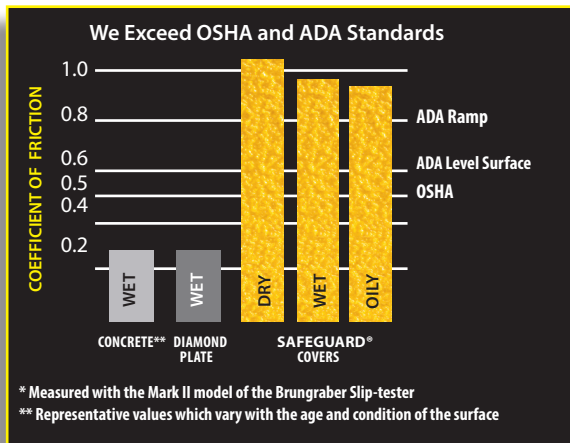

Sizes

All Safeguard® 1 mm FRP Walkway Covers are cut to your size specifications. The maximum size sheet available with PSA (Pressure Sensitive Adhesive) is 48" x 48." Larger sizes without PSA are available. Please call for details.

Grades

Safeguard® 1 mm FRP Walkway Covers are available in five grades of coarseness to meet your specific application requirements.



Heel and toe pattern creates a Hi-Traction® Anti-Slip Walkway on concrete

Coefficient of Friction

Safeguard Technology's unique surface nearly doubles both the OSHA's 0.5 and the ADA's 0.6 guidelines for Coefficient of Friction values as confirmed in independent lab testing using the Mark II Model of the Brungraber slip tester. Even in wet or oily conditions, we greatly exceed both of these guidelines.

Colors

The 1 mm FRP Walkway Covers are available in a variety of standard & premium colors as well as Photoluminescent "Glow-in-the-Dark" and custom color matching. Colors can be combined for a two-tone configuration. Incorporate your corporate logo, descriptive messages, and Personal Protection Equipment (PPE) symbols as well.

*See our Colors brochure for complete details.

Approximate weight in lbs/square foot with & without Pressure Sensitive Adhesive (PSA)

GRADE	Without PSA	With PSA
Super Fine	0.57	0.64
Extra Fine	0.61	0.68
Fine	0.68	0.75
Coarse	0.76	1.20
Extra Coarse	1.14	2.45

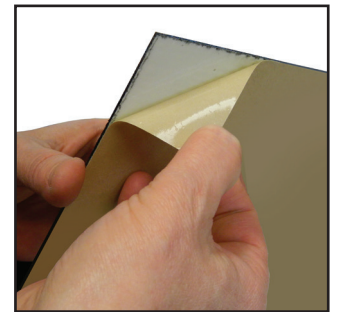

Peel and stick with Pressure-Sensitive Adhesive (PSA)

Thickness Comparison Detail

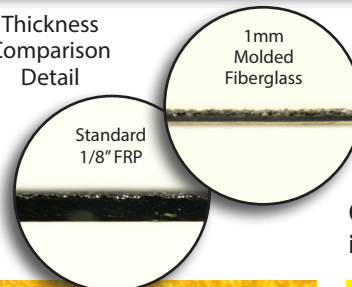

Contact Safeguard Technology for more information or a free sample today.

SAFEGUARD TECHNOLOGY
Leading Manufacturer of Anti-Slip Safety Products

SAFEGUARD TECHNOLOGY INC.

330.995.5200 | 800.989.1695 Toll-Free in the U.S. and Canada
Email: info@safeguard-technology.com
www.safeguard-technology.com

© Copyright 2016 SAFEGUARD TECHNOLOGY INC.
SAFEGUARD® Covers, Hi-Traction®, HiGlo-Traction®, and Roll-Traction® are registered trademarks of SAFEGUARD Technology Inc. REV2_122115

Average Thickness of Finished Product

Grit Coarseness	Super Coarse	Extra Coarse	Coarse	Fine	Extra Fine	Super Fine
Standard 1/8" FRP	0.38" 9.7mm	0.26" 6.6mm	0.19" 4.8mm	0.18" 4.6mm	0.17" 4.3mm	0.16" 4.1mm
1mm Molded Fiberglass	NA	0.12" 3.15mm	0.07" 1.8mm	0.07" 1.7mm	0.06" 1.5mm	0.05" 1.3mm

Anti-Slip Hi-Traction® LADDER RUNG COVERS

SAFEGUARD
TECHNOLOGY
Leading Manufacturer of Anti-Slip Safety Products

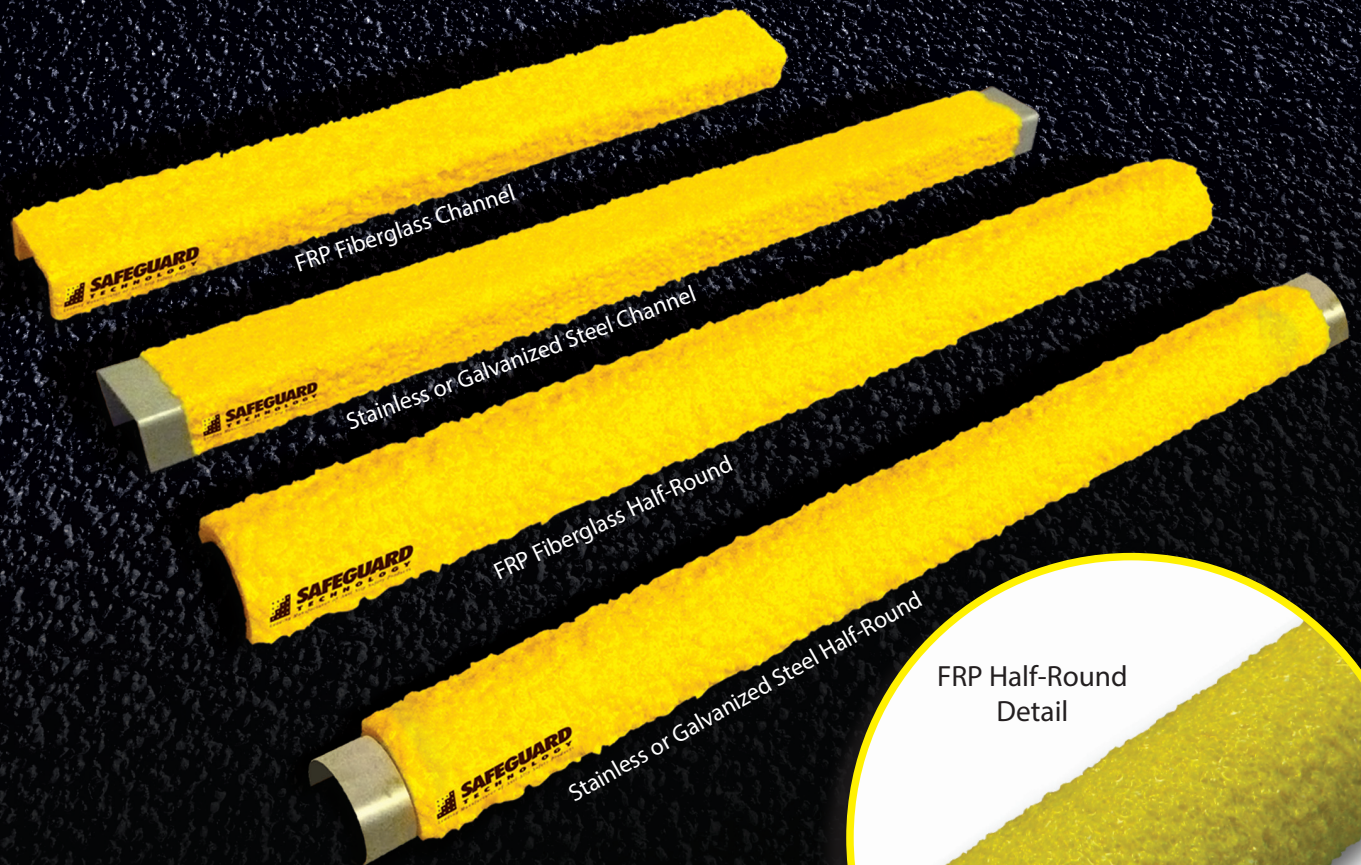

FRP Half-Round
Detail

Anti-Slip Ladder Rung Covers Prevent Costly Slips-and-Falls!

Hi-Traction® Anti-Slip Ladder Rung Covers are corrosion and impact resistant, providing years of slip prevention in a variety of environments - from offshore drilling platforms to residential applications.

Anti-Slip Hi-Traction® LADDER RUNG COVERS

SAFEGUARD® Hi-Traction® Ladder Rung Covers
Deliver firm footed traction from top to bottom.

Ladder Rung Covers

Suitable for use indoors and out, in all types of weather and harsh conditions, our pre-fabricated Covers are resistant to impact, chemicals, and corrosives.



Base Material Options For Your Application

Choose from one of the following base materials of construction.

- 1/8" (3mm) Pultruded FRP Fiberglass
- 18ga (1.2mm) Stainless Steel
- 18ga (1.2mm) G90 Galvanized Steel
- Customer Supplied Materials

Base Material Shapes

Anti-Slip Ladder Rung Covers are available in two different material shapes to address your application:

- Channel
- Half-Round

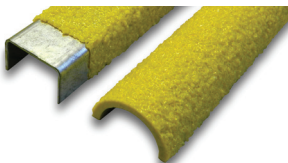

Choose Your Grade

We offer 5 different grades of grit, depending on your application. Fine grade (Commercial) is the standard choice for most ladder applications.

Standard Dimensions, Sizes, and Colors

- Standard diameters range from 3/4" to 2"
- Custom Lengths available.
- Order in a range of standard safety colors, two-tone configurations, custom colors and photoluminescent "glow-in-the-dark" options.

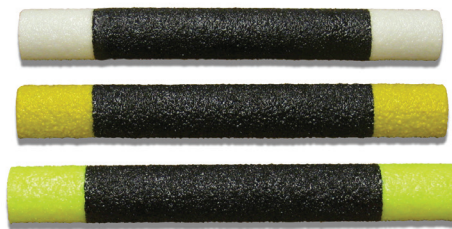

Photoluminescent "Glow-in-the-Dark" colors available



Daytime and Nighttime



Direct Gritting To Your Ladder Rungs

Direct rung gritting is a cost effective option, particularly at the OEM level, when retrofit Covers are not desirable. If you have finished rungs but do not want to adhere or screw a Cover over them, rungs or assemblies can be shipped directly to Safeguard where the Anti-Slip surface is applied.

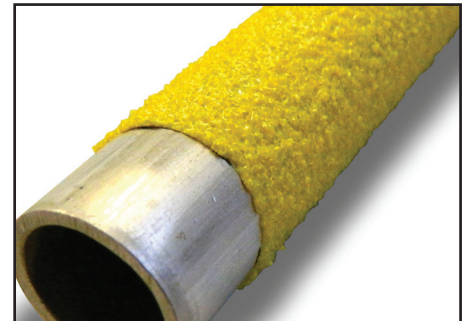

Example of Direct Gritting of customer supplied rung

Retrofit design for easy installation

- Sikaflex 252 adhesive
- Tack welding
- Mechanical fasteners

Contact Safeguard Technology for more information and a free sample cover today



SAFEGUARD TECHNOLOGY INC.

330.995.5200 | 1.800.989.1695 Toll-Free in the U.S. and Canada
Email: info@safeguard-technology.com
www.safeguard-technology.com

© Copyright 2016 SAFEGUARD TECHNOLOGY INC.
SAFEGUARD® Covers, Hi-Traction®, HiGlo-Traction®, and Roll-Traction® are registered trademarks of SAFEGUARD Technology Inc. REV2_122115

Base Material		Inches	Millimeters
Pultruded FRP Round and Channel	Lengths	Up to 48"	Up to 1,200mm
	Diameters	3/4 up to 2"	19 up to 50mm
Metal Channel	Lengths	Up to 48"	Up to 1,200mm
	Diameters	3/4 up to 2"	19 up to 50mm
Metal Round	Lengths	Up to 20"	Up to 500mm
	Diameters	Call for availability	

Anti-Slip Hi-Traction® PIPE & CABLE COVERS

SAFEGUARD
TECHNOLOGY
Leading Manufacturer of Anti-Slip Safety Products



Pipe and Cable Covers Safely Bridge Wires, Cables, Conduit, and Pipes.

The SAFEGUARD® Hi-Traction® and HiGlo-Traction® surface provides the Anti-Slip protection you need.



Anti-Slip Hi-Traction® PIPE & CABLE COVERS

SAFEGUARD® Hi-Traction® Pipe & Cable Covers
Safely bridging wires, cables, pipes and conduit.

Pipe and Cable Covers

Safeguard Pipe & Cable Covers are designed to provide a non-slip safety bridge over dangerous trip-and-fall hazards.

Rugged Construction

Available in maximum lengths of 10 feet, the Pipe & Cable Cover is designed for foot traffic or light equipment only. The Pultruded Composite Polymer is corrosion resistant and flame retardant.

Colors

Standard Safeguard® Pipe & Cable Covers are manufactured in Safety Yellow with a Black edging configuration. To custom design your Cover, choose from a variety of colors, including photoluminescent "Glow-in-the-Dark," or incorporate descriptive messaging such as "Watch Your Step" for added safety.

Grades

We offer 6 different grades of grit, depending on your application.

Installation

Pipe & Cable Covers are easily installed using mechanical fasteners and/or liquid adhesive. Please refer to Section 2 of our Installation Instructions literature for complete step-by-step details.

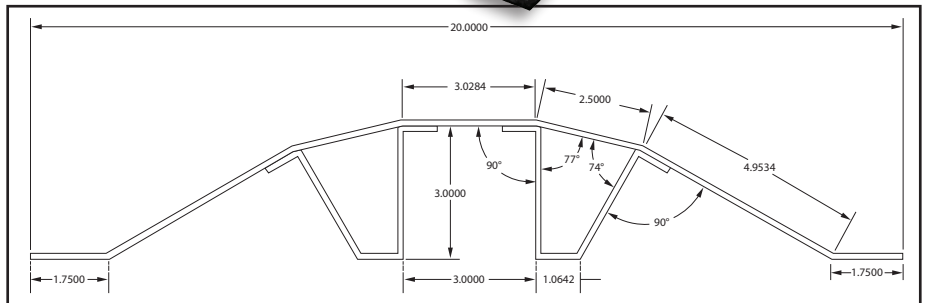

Contact Safeguard Technology today for more information.



SAFEGUARD TECHNOLOGY INC.

330.995.5200 | 800.989.1695 Toll-Free in the U.S. and Canada
Email: info@safeguard-technology.com
www.safeguard-technology.com

© Copyright 2016 SAFEGUARD TECHNOLOGY INC.
SAFEGUARD® Covers, Hi-Traction®, HiGlo-Traction®, and Roll-Traction® are registered trademarks of SAFEGUARD Technology Inc. REV2_122115

Anti-Slip Hi-Traction® LANDING COVERS

SAFEGUARD
TECHNOLOGY
Leading Manufacturer of Anti-Slip Safety Products



Safeguard® Landing Covers

The flexibility of large area coverage with a Walkway Cover, combined with the functionality of a Step Cover to address the leading edge on a step.



Anti-Slip Hi-Traction® LANDING COVERS

SAFEGUARD® Landing Covers combine the size of a Walkway Cover with the critical “wrap” design of a Step Cover.

Design.

Designed to provide a seamless Cover on stair landings, these Covers are available in a maximum width of 94” and a depth of 47”. The Landing Covers feature a “└” shaped design to wrap over the leading edge of a step where a majority of slips-and-falls occur.

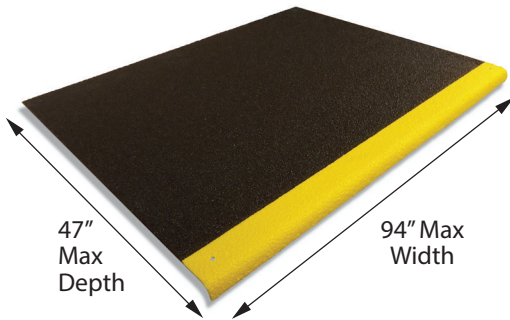

Coefficient of Friction

Safeguard Technology's unique surface nearly doubles both the OSHA's 0.5 and the ADA's 0.6 guidelines for Coefficient of Friction values as confirmed in independent lab testing using the Mark II Model of the Brungraber slip tester. Even in wet or oily conditions, our Safety Covers greatly exceed these guidelines.

Choose Your Grade

We offer 6 different grades of grit, depending on your application. These include Super Coarse (for extreme conditions), Extra Coarse (for offshore and heavy duty use), Coarse (for industrial environments), Fine (for commercial buildings), Extra Fine (for residential steps) and Super Fine (for showers and barefoot areas).

Choose Your Colors

Select from a wide range of standard, premium, or custom colors. Please refer to our Standard and Premium Colors literature page.

Two-Tone Colors Add Visibility

For added safety, our two-tone Landing Covers call attention to the edge of the step. A contrast between the step edge and the back of the tread below provides good definition and clear visibility.

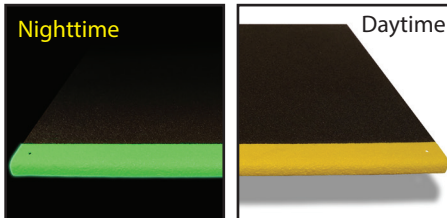

Glow-in-the-dark

Safeguard also offers photoluminescent HiGlo-Traction® Landing Covers which are visible for several hours after the light source is removed.

Descriptive Markings and Logos

We can incorporate logos, PPE symbols, escape route information, and directional markings on our Covers. Our Safeguard Descriptive Marking is inlaid and will last for the life of the product.

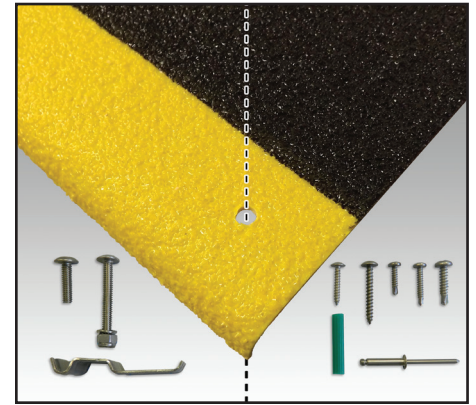

Quickly installed using mechanical fasteners or adhesive.

Easy Installation and Cleaning

Safeguard® Hi-Traction® Landing Covers are prefabricated, retrofit Covers which are quickly and easily installed over existing surfaces, such as concrete, wood, metal plate and grating using mechanical fasteners or adhesive. Installation is quick, easy and requires little to no downtime. Cleanup is easy with a non-solvent cleaner and a stiff brush. Refer to our cleaning and installation insert for complete details. Safeguard® Hi-Traction® Landing Covers are not load bearing.

Physical Properties

Please refer to our General Properties insert for complete physical properties and mechanical specifications.

Contact Safeguard Technology for more information or a free sample today.



SAFEGUARD TECHNOLOGY INC.

330.995.5200 | 800.989.1695 Toll-Free in the U.S. and Canada
Email: info@safeguard-technology.com
www.safeguard-technology.com

© Copyright 2016 SAFEGUARD TECHNOLOGY INC.
SAFEGUARD® Covers, Hi-Traction®, HiGlo-Traction®, and Roll-Traction® are registered trademarks of SAFEGUARD Technology Inc. REV2_122115

Anti-Slip Hi-Traction®
DIRECT
GRITTING
Directly to Your Parts

SAFEGUARD
TECHNOLOGY
Leading Manufacturer of Anti-Slip Safety Products

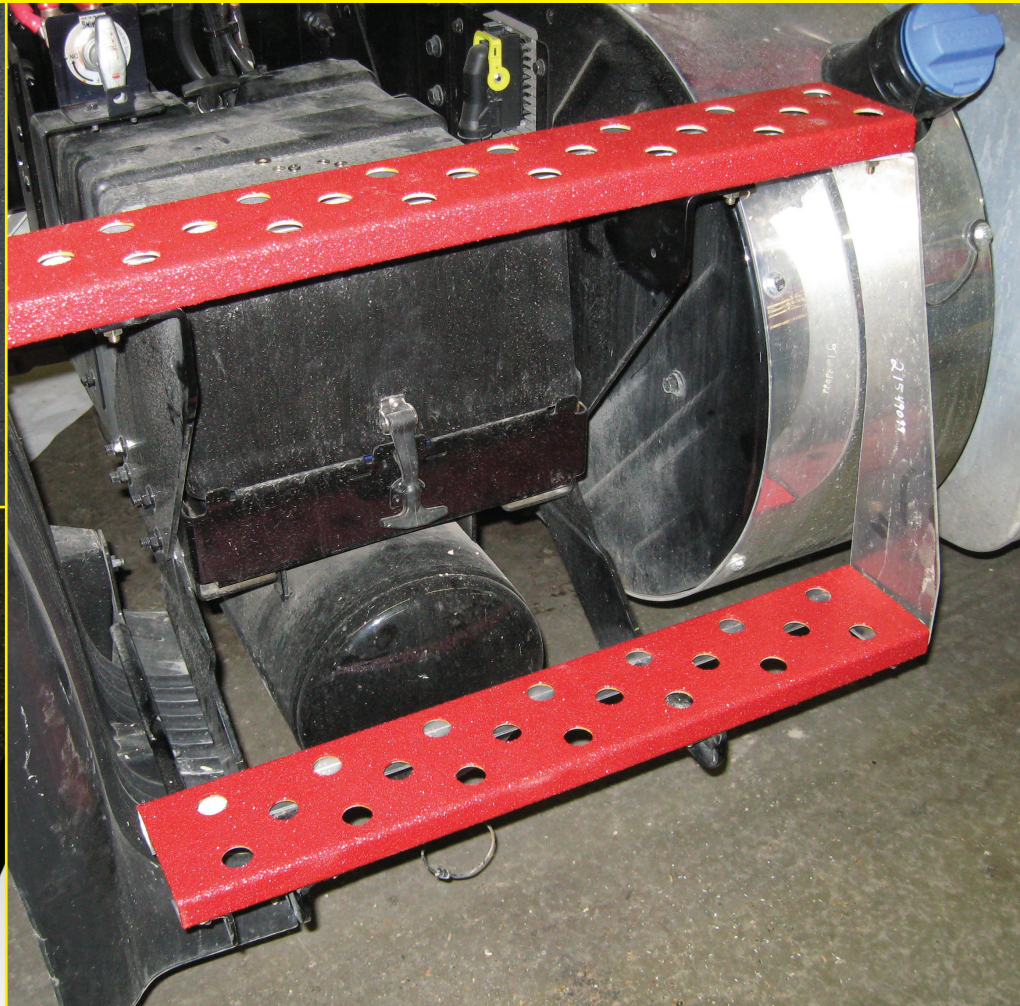
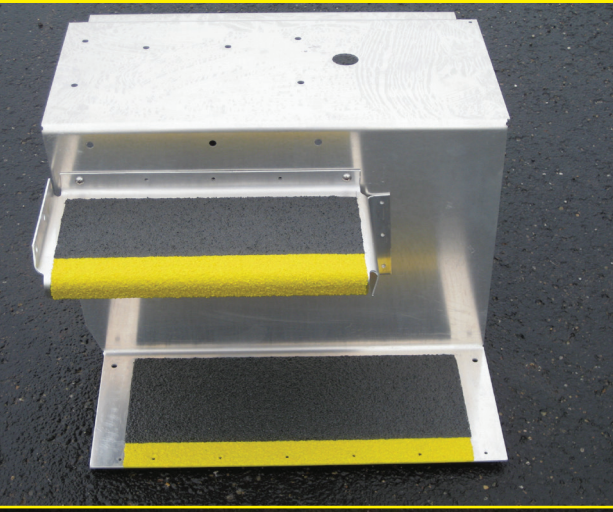

Safeguard® Hi-Traction® Surface on your parts.

SAFEGUARD Technology Inc. offers its Hi-Traction® Anti-Slip surface bonded directly to your supplied material; or provide your engineered drawings for in-house fabrication.



www.safeguard-technology.com

Step Covers | Walkway Covers | Ladder Rung Covers | Pipe & Cable Covers | Roll-Traction® | Anti-Slip Mats | Anti-Slip Tapes

Anti-Slip Hi-Traction®

DIRECT GRITTING

Directly to Your Parts

SAFEGUARD® Hi-Traction® Direct Gritting
Our Anti-Slip material bonded directly to your parts.

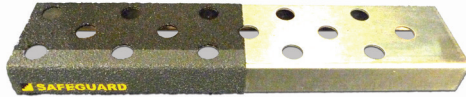

After

Before

Significant Cost Savings with World's Best Anti-Slip Surface

While a Safeguard® retrofit Anti-Slip Cover is often a great solution, having Safeguard apply the same superior gritted Anti-Slip surface directly to your parts can also save you direct labor time and money.

- **Reduce Direct Labor Costs** - Eliminate the time of having to separately install an Anti-Slip Cover or other Anti-Slip material.
- **Stock Fewer Parts** - No need to procure and stock two parts: load-bearing parts and Anti-Slip Covers.
- **Long-Lasting Anti-Slip Surface** - Tapes and coatings often leave end-users with a worn down slippery surface in a short time.
- **No More Diamond Plate** - Cut costs by converting to flat steel with Safeguard bonded to the surface.
- **Reduce Weight** - Direct gritting eliminates the need for a cover thus minimizing the weight, fuel consumption, and wear on hydraulics.
- **Improve Aesthetics** - Eliminate unsightly screw heads and provide a new and clean non-slip surface.

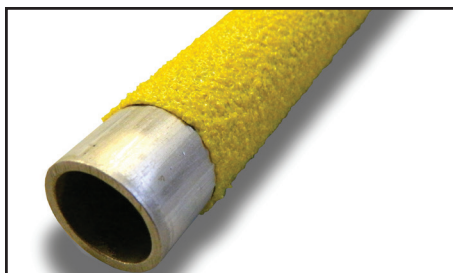

Ideal for OEM and Aftermarket

Transportation

- Steps for Work Trucks
- Bus Trim Parts
- Bus Ramps



Industrial

- Metal Stair Treads
- Diamond Plate
- Ladder Rungs



Customize the Color, Grit, and Message To Suit Your Needs

- As with our Hi-Traction® Covers, we can customize colors, grit level, and messaging.
- Available in almost any color including safety colors, commercial/residential colors, glow-in-the-dark, two tone, and custom color matching.
- Available in six grit levels from super fine to super coarse.
- Also available with custom logos, safety messaging and PPE (personal protective equipment) symbols.

How Does It Work?

Option #1: Customer Supplied Material

You supply Safeguard with your parts and we apply our Hi-Traction® Anti-Slip surface in the color(s) and grit size you specify. This is done in a controlled environment at our facility.

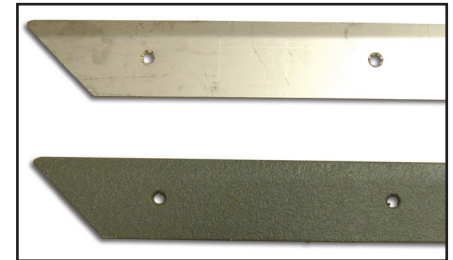

Option #2: Safeguard Fabrication

You provide Safeguard with part diagrams or engineered drawings, we have them fabricated to your specifications, and bond our Hi-Traction® Anti-Slip surface in the color(s) and grit size you specify.

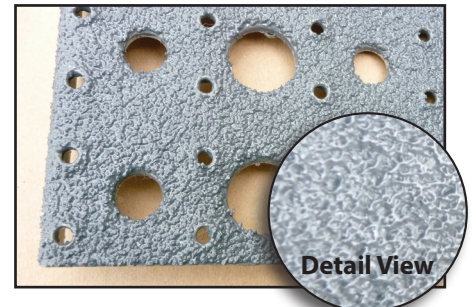

Contact Safeguard Technology for more information or a free sample today.

SAFEGUARD TECHNOLOGY
Leading Manufacturer of Anti-Slip Safety Products

SAFEGUARD TECHNOLOGY INC.

330.995.5200 | 800.989.1695 Toll-Free in the U.S. and Canada

Email: info@safeguard-technology.com

www.safeguard-technology.com

© Copyright 2016 SAFEGUARD TECHNOLOGY INC.
SAFEGUARD® Covers, Hi-Traction®, HiGlo-Traction®, and Roll-Traction® are registered trademarks of SAFEGUARD Technology Inc. REV2_122115

Anti-Slip Hi-Traction®
MAT-TRACTION®
Modular and Large Size Gritted Mats

SAFEGUARD
TECHNOLOGY
Leading Manufacturer of Anti-Slip Safety Products



Grit Detail

A Portable Solution For Slips-And-Falls In Commercial, Industrial, and Offshore Applications.

SAFEGUARD Technology offers Anti-Slip Floor Mats that can be put down as large section mats or built in modular configurations for custom fit applications to help prevent slips and falls. These mats offer slip resistance, portability, ergonomics, fluid resistance, and “pass through” design for particle and debris clearing benefits.



www.safeguard-technology.com

Step Covers | Walkway Covers | Ladder Rung Covers | Pipe & Cable Covers | Roll-Traction® | Anti-Slip Mats | Anti-Slip Tapes

Anti-Slip Hi-Traction® MAT-TRACTION®

Modular and Large Size Gritted Mats

Mat-Traction® combines the ergonomics and mobility of industrial mats with the renowned Safeguard Technology Anti-Slip system featuring Fused Alumina Aggregate, to create the perfect solution in portable safety.

Ergo-Cushion

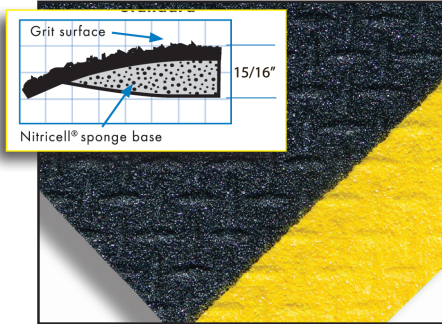

Thickness	Base Material	Grit Type	Application(s)	Properties	Colors	Sizes
15/16"	Ultra Soft Nitrile Rubber Composite Sponge	Fused-Alumina Aggregate	Dry, Slight overspray or oil tracking, assembly lines	Sponge base, tapered edges, high comfort, & anti fatigue	Solid black or black with yellow edging	2' x 3' 3' x 5'

Ergo-Cushion diamond-plate mats are designed for ergonomic comfort in dry areas with slight overspray or oil tracking. Combine superior slip prevention with the comfort necessary for long periods on your feet. Choose from Residential (Extra Fine), Commercial (Fine), or Industrial (Coarse) grade grit depending on your application. Available colors include solid black or black with yellow tapered edging to prevent trips.

Interlocking Tiles (Hard or Soft)

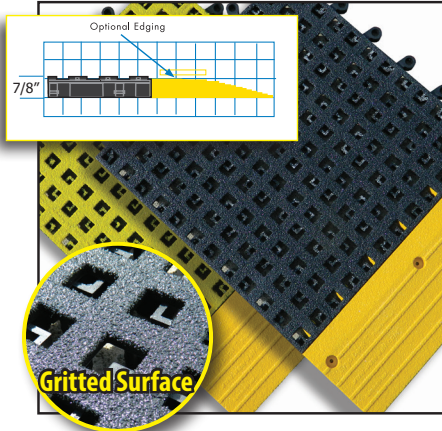

Thickness	Base Material	Grit Type	Application(s)	Properties	Colors	Sizes
7/8" Hard	100% Silicone-Free PVC	Fused-Alumina Aggregate	Heavy use and cart traffic	• Easy to connect 18" tiles, • Open holes for drainage	Yellow or black with optional yellow edging	Modular 18" Tiles, connect tiles as needed
7/8" Soft			Wet, overspray, oil, and Ergonomic comfort	• Easy to connect 18" tiles • Emphasis on comfort • Open holes for drainage	Gray with optional yellow edging	

Interlocking Tiles feature an interlocking flooring system designed for quick assembly, providing a seamless installation ideal for any size area. Choose from durable **HARD** tiles, intended for heavy use and cart traffic areas or **SOFT** tiles with a softer composition for increased ergonomics and greater worker comfort during long periods of standing. Choose from Residential (Extra Fine), Commercial (Fine), or Industrial (Coarse) grade grit depending on your application. **HARD** tiles are standard in Black; **SOFT** in Gray. Optional yellow ramps and corners are available for both.

Chemical Resistant

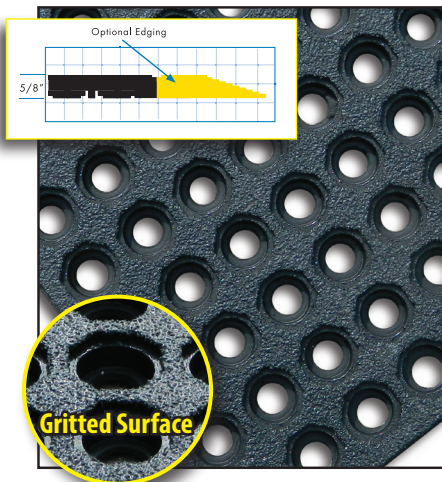

Thickness	Base Material	Grit Type	Application(s)	Properties	Colors	Sizes
5/8" CFR	CFR Compound	Fused-Alumina Aggregate	Heavy duty, wet, and chemical resistant	CFR - Resist minerals and oil fluids	Black with optional black or yellow edging	3' x 3' or custom
5/8" NBR	100% Nitrile Compound			NBR - Resists petro-based fluids		

High performance **Chemical Resistant Mats** feature your choice of two rubber compounds formulated to withstand chemical exposure: **CFR** (Cutting Fluid Resistant) resists mineral oil-based cutting fluids and **NBR** (100% Nitrile) is designed for petrochemical resistance. The concealed interlocking system presents a flooring configuration that is designed to be quickly assembled and securely connected, providing a seamless installation ideal for any size area. Choose from Residential (Extra Fine), Commercial (Fine), or Industrial (Coarse) grade grit size for your application. Chemical Resistant Mats come standard in black, with optional yellow tapered edging.

Optional Edging Ramps

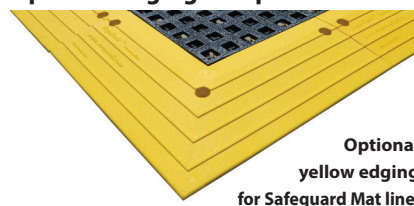

Optional yellow edging for Safeguard Mat line.

Improve Safety and Visibility - Optional "Safety Yellow" ramps, edging, and corners available for the **Interlocking Tiles** and the **Chemical Resistant CFR & NBR** product line.



SAFEGUARD TECHNOLOGY INC.
330.995.5200 | 800.989.1695 Toll-Free in the U.S. and Canada
Email: info@safeguard-technology.com
www.safeguard-technology.com

© Copyright 2016 SAFEGUARD TECHNOLOGY INC.
SAFEGUARD® Covers, Hi-Traction®, HiGlo-Traction®, and Roll-Traction® are registered trademarks of SAFEGUARD Technology Inc. REV2_122115

**Anti-Slip
TAPES**
Cost Effective Slip Prevention



Quickly Reduce Slips and Falls in Non-Harsh Environments.

SAFEGUARD Technology Inc. offers a complete line of Anti-Slip Tape in a variety of grits and color combinations. Tapes provide a cost effective, immediate solution, for slip and fall issues in low traffic, non-harsh environments.



Anti-Slip TAPES

Cost Effective Slip Prevention

Anti-Slip Tapes
Quickly and economically reduce slips-and-falls.



Safety Track® 3100
Commercial Duty

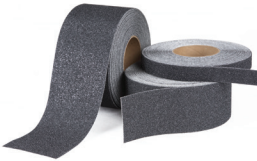

Safety Track® 3200
Industrial Duty



Safety Track® 3700
Conformable Foil Backed



Safety Track® 3400
Glo Brite®



Safety Track® 3300
Commercial Colors

Application	Sizes Available	Note	Colors
<ul style="list-style-type: none"> For general purpose applications, indoor and outdoor. Durable, consistent non-slip surface, exceeds OSHA Standards. Silicon carbide grit ensures longevity. Aggressive, durable adhesive system. 	<ul style="list-style-type: none"> 2" x 60' Roll 4" x 60' Roll 6" x 60' Roll 6" x 24" Tread (10 pcs. per case) 6" x 24" Tread (50 pcs. per case) 	Other colors, sizes and shapes available upon request.	<ul style="list-style-type: none"> Black
<ul style="list-style-type: none"> Premium grade, coarse grit for industrial anti-slip needs. Stands up to oil, diesel fuel, mud, extreme OEM environments. Silicon carbide grit ensures a consistent, long-lasting "high slip resistance". Designed adhesive system to meet the strict application requirements. 	<ul style="list-style-type: none"> 2" x 60' Roll 4" x 60' Roll 6" x 60' Roll 6" x 24" Tread (50 pcs. per case) 	Other colors, sizes and shapes available upon request.	<ul style="list-style-type: none"> Black
<ul style="list-style-type: none"> Foil backed non-slip tape conforms to most any irregular surface. Excellent stability in high to low temperature range. Provides high traction surfaces for indoor and outdoor applications. Good for ladder rungs, radius corners, diamond plate, other raised surfaces. 	<ul style="list-style-type: none"> 2" x 60' Roll (6 rolls per case) 6" x 24" Tread (50 pcs. per case) 	Other colors, sizes and shapes available upon request.	<ul style="list-style-type: none"> Black
<ul style="list-style-type: none"> Affordable choice for emergency egress anti-slip protection. Glow-in-the-dark solution for marking stairs and corridors. Photoluminescent tape will adhere to most clean, dry, oil-free surfaces. Glo Brite® #3450 meets rigid ASTM and NYC (MEA # 235-05-M) standards 	<ul style="list-style-type: none"> 2" x 60' Roll 4" x 60' Roll 6" x 60' Roll 6" x 24" Tread (10 pcs. per case) 6" x 24" Tread (50 pcs. per case) 	Other colors, sizes and shapes available upon request.	<ul style="list-style-type: none"> Photoluminescent #3420 Photoluminescent NYC ASTM, #3450
<ul style="list-style-type: none"> Visual warning to mark potential slip and fall hazards. Available in a range of Safety and Commercial Colors. Available in Safety Messaging, e.g. "Watch Your Step". Ideal for commercial buildings and industrial applications. 	<ul style="list-style-type: none"> 2" x 60' Roll (6 rolls per case) 6" x 24" Tread (50 pcs. per case) 	Other colors, sizes and shapes available upon request.	<ul style="list-style-type: none"> Safety Red #3315 • Safety Orange #3320 • Safety Yellow #3335 Brick Red #3340 • Medium Brown #3345 • Concrete Gray #3350 Green #3355 • Speckled Yellow #3358 • Yellow/Black Stripes #3360 Yellow/Black, "Watch Your Step," #3360 (tread only) Yellow/Black, "Caution," #3360 (tread only) Snow White #3310 • Dark Blue #3325 Light Blue #3330 • Red/White Stripes #3365 Granite #3370 • Mop Friendly, Black #3375



Tapes can be ordered in a wide range of sizes, colors, and shapes. Please call for details on your particular application.



Contact Safeguard Technology for more information or a free sample today.



SAFEGUARD TECHNOLOGY INC.
330.995.5200 | 800.989.1695 Toll-Free in the U.S. and Canada
Email: info@safeguard-technology.com
www.safeguard-technology.com

© Copyright 2016 SAFEGUARD TECHNOLOGY INC.
SAFEGUARD® Covers, Hi-Traction®, HiGlo-Traction®, and Roll-Traction® are registered trademarks of SAFEGUARD Technology Inc. REV2_122115

Anti-Slip Hi-Traction®
ROLL-TRACTION®
Anti-Slip Walkway Cover

SAFEGUARD
TECHNOLOGY
Leading Manufacturer of Anti-Slip Safety Products

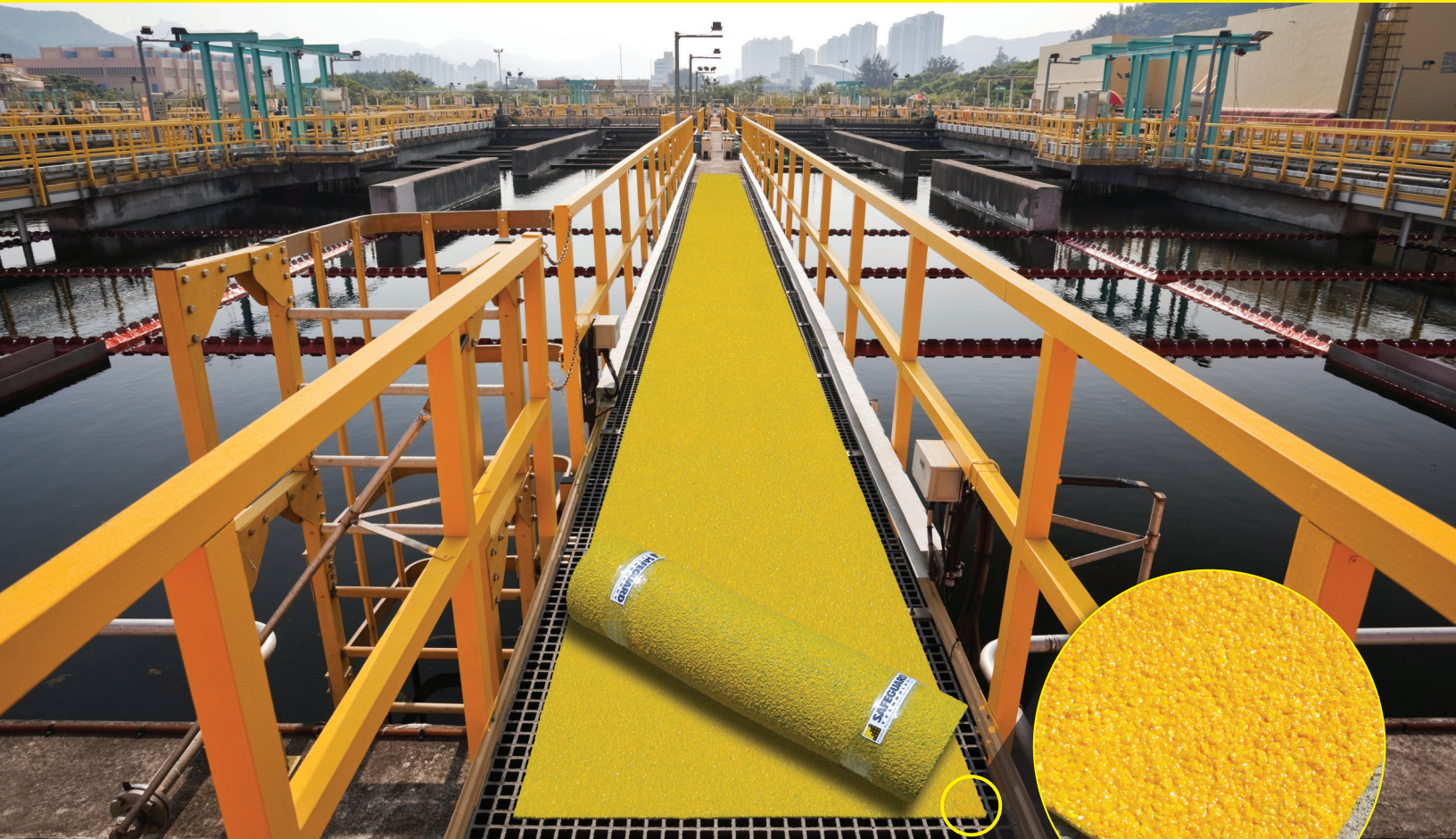

Cost Effective and Portable Solution for Slips-and-Falls over large areas.

SAFEGUARD® Roll-Traction® Walkway Covers are a durable, pliable, and portable solution for eliminating slips and falls on wet, oily, and slippery surfaces.



www.safeguard-technology.com

Step Covers | Walkway Covers | Ladder Rung Covers | Pipe & Cable Covers | Roll-Traction® | Anti-Slip Mats | Anti-Slip Tapes

Anti-Slip Hi-Traction® ROLL-TRACTION® Anti-Slip Walkway Cover

SAFEGUARD® Roll-Traction®
Heavy-duty movable Walkway Cover
for large areas.



SAFEGUARD® Roll-Traction® Walkway Covers offer excellent protection against slips and falls.

Water, oils, and chemicals can create dangerous working surfaces when introduced on walkways, decks, and floors. By using SAFEGUARD® Roll-Traction® Anti-Slip Walkway Covers, a secure, anti-slip area can quickly and conveniently be created any where. This heavy duty, flexible polymeric geomembrane can be put down temporarily for easy removal and cleaning. Roll-Traction® can also be secured by mechanical fasteners or adhesives for a more permanent installation.

Grit and thickness to suit your application

Roll-Traction®		Average Thickness Inches	Average Thickness Millimeters
Grade	Coarse	0.101"	2.6mm
	Fine	0.095"	2.4mm
	Extra Fine	0.087"	2.2mm
	Super Fine	0.080"	2.0mm

Average Weight: 0.8lb / Sq. foot (0.36kg. / Sq. meter) with Coarse grade grit

Maximum Available Sizes

Roll-Traction®	
Width	Length
29" Width	40' Max Length
(.75m) 736.6mm Width	12m Max Length
40" Width	30' Max Length
(1m) 1016mm Width	9m Max Length
58" Width	20' Max Length
(1.5m) 1473.2mm Width	6m Max Length

**Custom widths are available in combined lengths over 126' or 38.4m*
***Super Coarse/Xtreme and Extra Coarse are not available on Roll-Traction®*



- Prevents slips and falls
- Impact & puncture resistant
- Easily installed
- Non-conductive
- High strength
- Corrosion resistant
- Can be rolled for storage
- Meets OSHA & ADA Coefficient of Friction Guidelines

Superior Coefficient of Friction
SAFEGUARD® Technology's Hi-Traction® surface nearly doubles both OSHA 0.5 and ADA 0.6 guidelines for Coefficient of Friction values¹, even in wet or oily conditions.

¹Confirmed in independent lab testing using the Mark II Model of the Brungraber slip tester.

Grit Sizes and Color

Choose from four grades of grit (not available in Super Coarse/Xtreme or Extra Coarse/Offshore) and standard colors only. Due to the length of the rolls, two-tone color configurations are only available at the ends, across the width of the Cover. Glow Colors can be done in two-tone configurations and are only on the ends of the Roll-Traction®.

Contact Safeguard Technology for more information or a free sample today.



SAFEGUARD TECHNOLOGY INC.
330.995.5200 | 1.800.989.1695 Toll-Free in the U.S. and Canada
Email: info@safeguard-technology.com
www.safeguard-technology.com

© Copyright 2016 SAFEGUARD TECHNOLOGY INC.
SAFEGUARD® Covers, Hi-Traction®, HiGlo-Traction®, and Roll-Traction® are registered trademarks of SAFEGUARD Technology Inc. REV2_122115

Anti-Slip Hi-Traction®
WELD TAB COVERS
Secure and Permanent Anti-Slip Protection

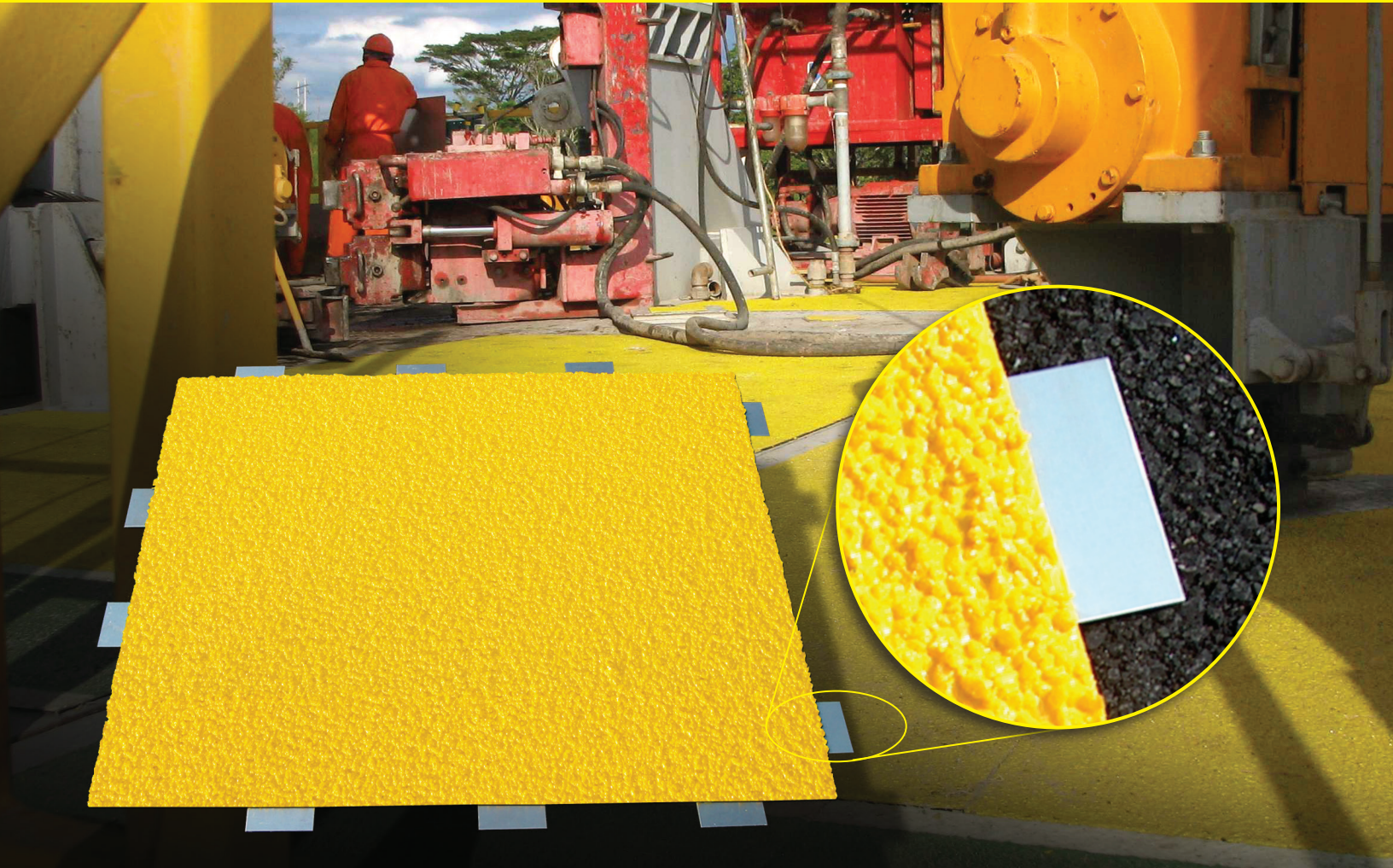

SAFEGUARD® Anti-Slip Walkway Covers
Weld-In Installation.

Safeguard Technology's Weld-Tab Anti-Slip Walkway Covers work in areas where adhesives and mechanical fasteners will not allow traditional installation methods.



Anti-Slip Hi-Traction® WELD TAB COVERS

Secure and Permanent Anti-Slip Protection

SAFEGUARD® Hi-Traction® Weld-Tab Walkway Covers
For areas where mechanical fasteners or adhesives just won't work!

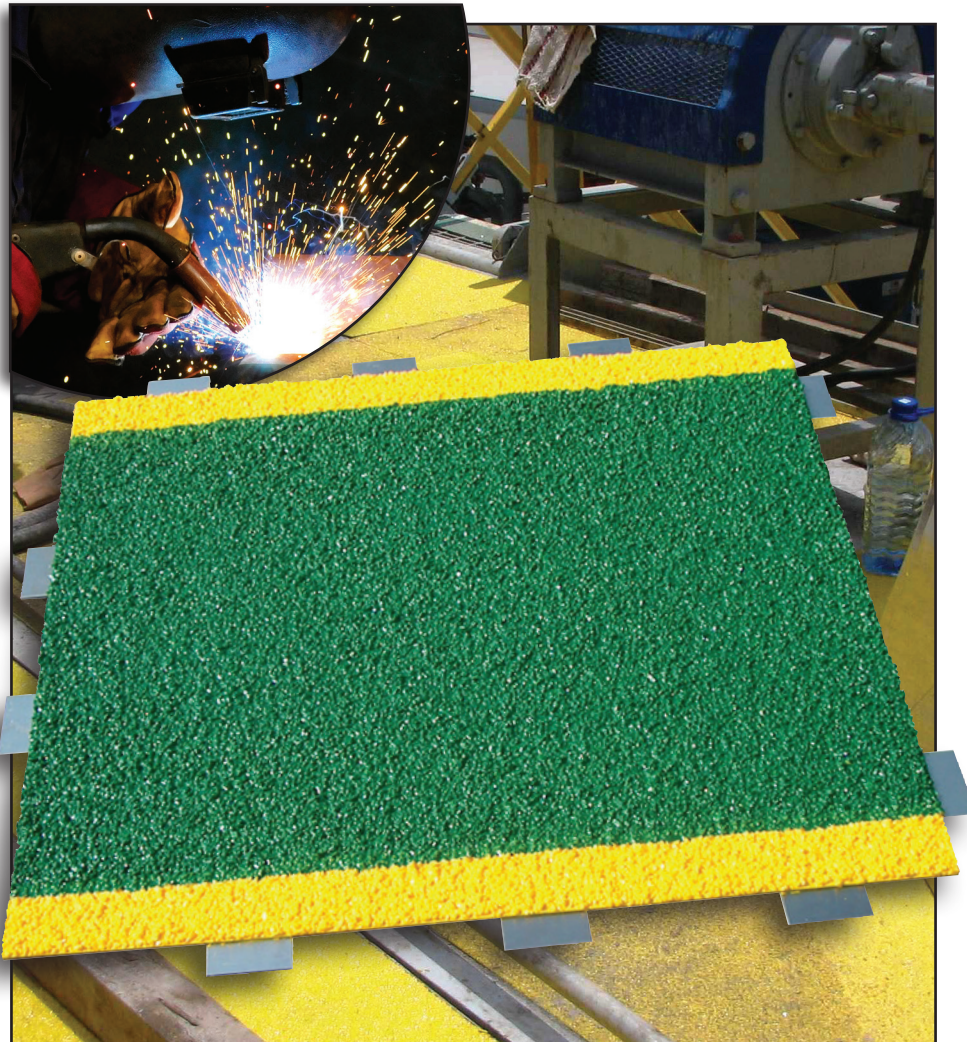

Grit Coarseness & Custom Colors

Safeguard® Hi-Traction® Weld Tab Anti-Slip Walkway Covers are only offered in Xtreme® and Offshore Grit sizes. Safeguard also offers several color options, including one and two-tone configurations, and photoluminescent "glow-in-the-dark" for added safety. This will add an extra level of protection during power failures providing safe egress when the light source is removed.



PPE Symbols and Safety Messaging

Safety Messaging and PPE Symbols can easily be incorporated into the Anti-Slip surface for further safety.



Weld-In Anti-Slip Panels

When drilling platforms become wet, muddy, and oily, Anti-Slip protection is essential. Safeguard offers a Hi-Traction® Weld Tab Anti-Slip Walkway Cover that allows you to install a gritted Anti-Slip surface without the use of screws or adhesives.

These heavy-duty Walkway Covers are manufactured from 1/8" Pultruded FRP Fiberglass and utilize 4" x 4" 316 stainless steel metal tabs attached around the edge of the Cover. Weld Tab Covers are designed to allow tack-welding directly to the metal/steel substrate. The Covers are not recommended to be welded to one-another.

Sizes

Hi-Traction® Weld Tab Anti-Slip Walkway Covers are available in custom sizes to meet your specifications. Provide your work area dimensions and make note of where existing non-movable machinery and equipment are located; we will assist you in developing the most cost efficient strategy for your application.

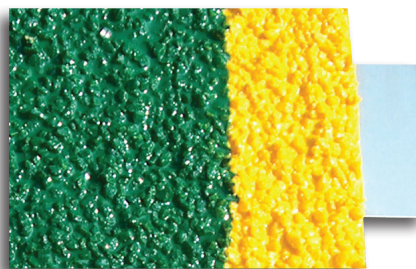

Contact Safeguard Technology for more information or a free sample today.

SAFEGUARD
TECHNOLOGY
Leading Manufacturer of Anti-Slip Safety Products

SAFEGUARD TECHNOLOGY INC.
330.995.5200 | 800.989.1695 Toll-Free in the U.S. and Canada
Email: info@safeguard-technology.com
www.safeguard-technology.com

© Copyright 2016 SAFEGUARD TECHNOLOGY INC.
SAFEGUARD® Covers, Hi-Traction®, HiGlo-Traction®, and Roll-Traction® are registered trademarks of SAFEGUARD Technology Inc. REV2_122115

SAFEGUARD COLOR PALLET

For Hi-Traction® and HiGlo-Traction®
Product Lines

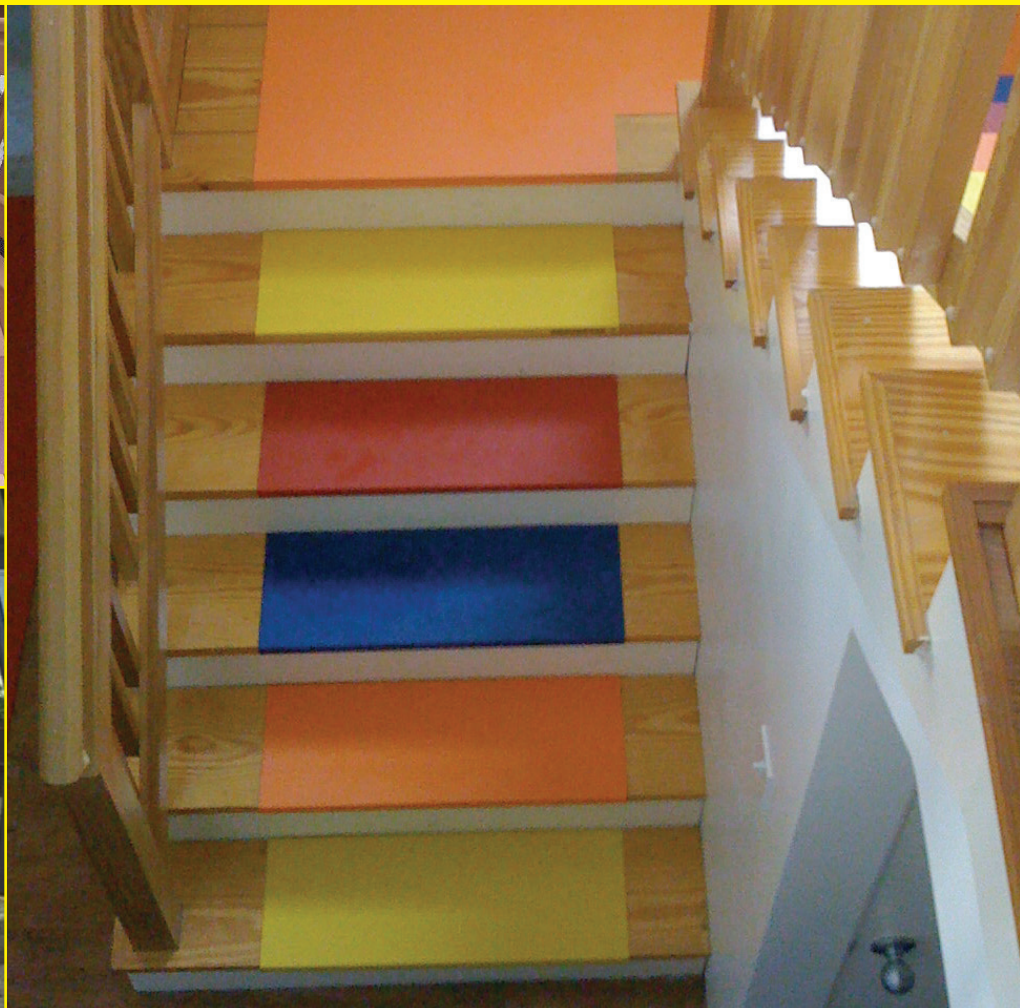

SAFEGUARD COLOR GUIDE

SAFEGUARD Technology Inc. offers our complete line of Hi-Traction® and HiGlo-Traction® Anti-Slip Covers in solid colors, two tone color configurations, as well as photoluminescent Glow-in-the-Dark.



SAFEGUARD COLOR PALLET

For Hi-Traction® and HiGlo-Traction®
Product Lines

SAFEGUARD® Hi-Traction® & HiGlo-Traction® Covers are available in various color options to meet the needs of safety-minded customers.

Safeguard® Anti-Slip Products are available in a variety of colors to meet the needs of safety-minded customers. Choose from a range of solid colors or combine colors for a two-tone configuration, accentuating the leading edge or creating boundaries for added visual safety awareness.

Color Pallet

In addition to standard and safety colors, Safeguard also offers a line of premium colors. Based upon popular trends and subtle color hues, the premium line fits well with the aesthetic requirements for Anti-Slip safety at schools, commercial buildings, hotels, restaurants, and residential homes.

Photoluminescent "Glow-in-the-Dark" Pigment

HiGlo-Traction® Covers offer Anti-Slip protection with the added benefit of Photoluminescent "Glow-in-the-Dark." In addition to standard Photoluminescent, which is white when non-glowing, Safeguard offers Glo-Safety Yellow, Glo-Safety Lime, Glo-Green, Glo-Pink, and Glo-Orange. These Photoluminescent Safety Products use an embedded inorganic pigment that creates a glow when active. The pigment is non-toxic, non-radioactive, and can be recharged repeatedly throughout the life of the product.

Two-Tone Configurations:

Safeguard colors can be combined to create a two-tone configuration. Contrasting color on the nosing and vertical lip of a Step Cover, calls attention to the leading edge of a stair. Contrasting color on the perimeter of a Walkway Cover designates a change in surface texture and signifies a safe walk zone. Two-tone can also be configured on Ladder Rung Covers and is standard on all Pipe and Cable Covers.

An economical alternative to full 100% Photoluminescent Covers is a combination with a solid color. Not only do you have a two-tone configuration in the light, but also the benefit of Glow-in-the-Dark when the light source is removed.

* Due to the combination of aggregates used to achieve the "speckled effect," the following colors can only be combined with one another:

Speckle Photo • Brisbane Brick Red • Erie Blue
• PM Salmon • Garfield Gray • Grand River Gray
• Ipswich Olive • Ekriz Brown • Newbury Sky
• Mentor Sand • Hudson Hunter Green

Standard Color Options



Red

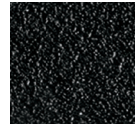

Black

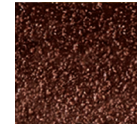

Brown

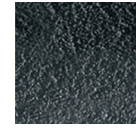

Gray



Safety Yellow

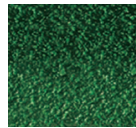

Green



Beige



White/Non-Glowing

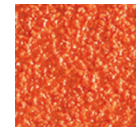

Orange

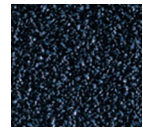

Blue



Fluorescent Green



Fluorescent Orange



Fluorescent Pink

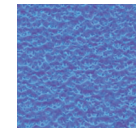

PPE Blue

Premium/SGT2100 Colors



Bainbridge Blue

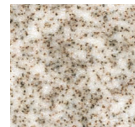

Speckle Photo



Brisbane Brick Red



Erie Blue

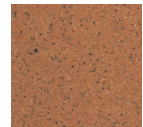

PM Salmon

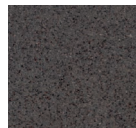

Garfield Gray

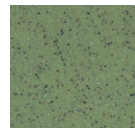

Ipswich Olive

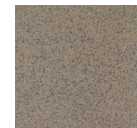

Ekriz Brown



Geauga Green

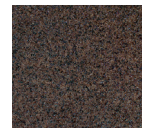

Chagrin Chocolate

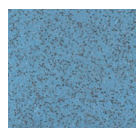

Newbury Sky



Grand River Gray

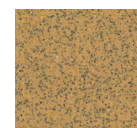

Mentor Sand

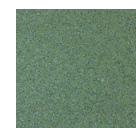

Hudson Hunter Green

HiGlo-Color Options

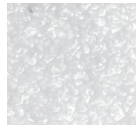

Glo-White



Glo-Orange



Glo-Safety Yellow



Glo-Pink



Glo-Lime

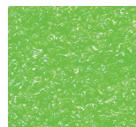

Glo-Green

Custom Color Matching:

In addition to stock colors, Safeguard has the ability to provide custom color matching. Please contact Safeguard for more information on this option.

Contact Safeguard Technology for more information or a free sample today.



SAFEGUARD TECHNOLOGY INC.

330.995.5200 | 800.989.1695 Toll-Free in the U.S. and Canada
Email: info@safeguard-technology.com
www.safeguard-technology.com

© Copyright 2016 SAFEGUARD TECHNOLOGY INC.
SAFEGUARD® Covers, Hi-Traction®, HiGlo-Traction®, and Roll-Traction® are registered trademarks of SAFEGUARD Technology Inc. REV2_122115

The samples on this sheet serve only as a visual guide for initial selection of color. Actual finished product color may vary slightly from the printed images based on grit size (coarseness) as well as the base material of construction.

For an accurate depiction, please request a product sample.

Anti-Slip HiGlo-Traction®
PHOTOLUMINESCENT
Glow-In-The-Dark Colors

SAFEGUARD
TECHNOLOGY
Leading Manufacturer of Anti-Slip Safety Products

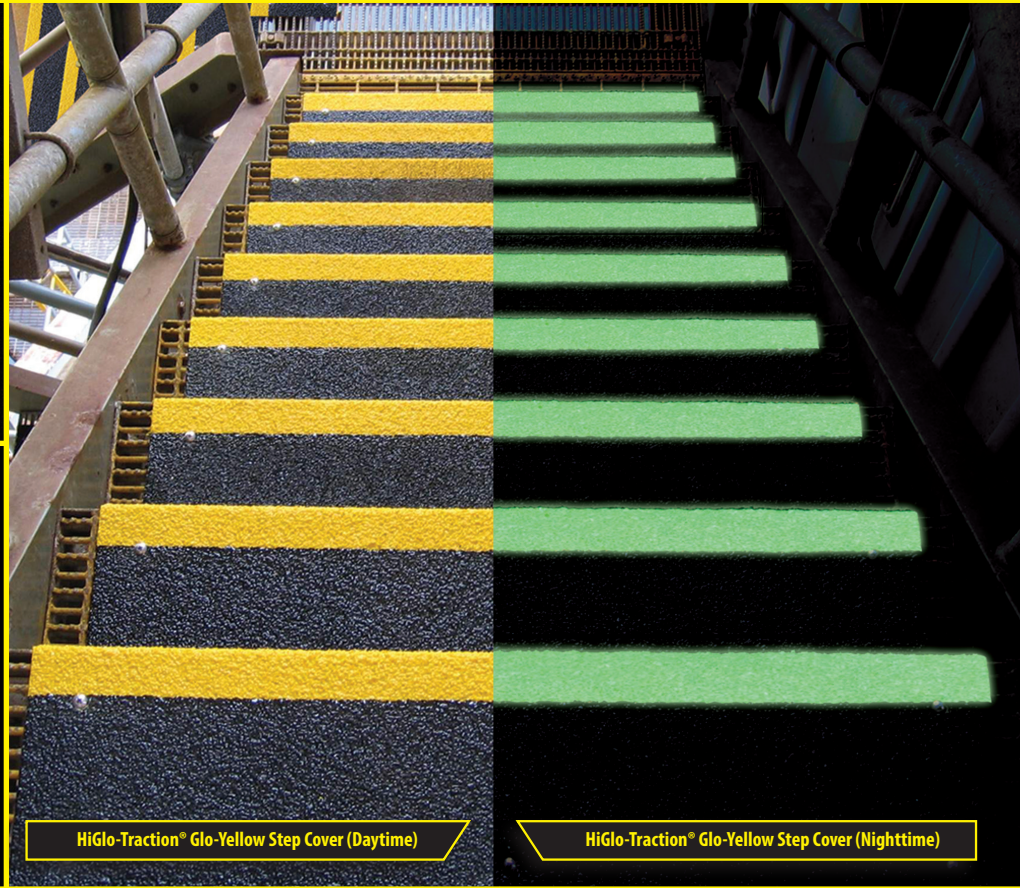

HiGlo-Traction® Glo-Yellow Step Cover (Daytime)

HiGlo-Traction® Glo-Yellow Step Cover (Nighttime)



When Darkness Falls, Light The Way To Safety While Providing Anti-Slip Protection.

SAFEGUARD® HiGlo-Traction® Covers for steps, ladders and walkways are proven to be visible for hours after the light source is removed.



www.safeguard-technology.com

Step Covers | Walkway Covers | Ladder Rung Covers | Pipe & Cable Covers | Roll-Traction® | Anti-Slip Mats | Anti-Slip Tapes

Anti-Slip HiGlo-Traction® PHOTOLUMINESCENT Glow-In-The-Dark Colors

SAFEGUARD® HiGlo-Traction® Covers Egress and Slip Prevention all in one!

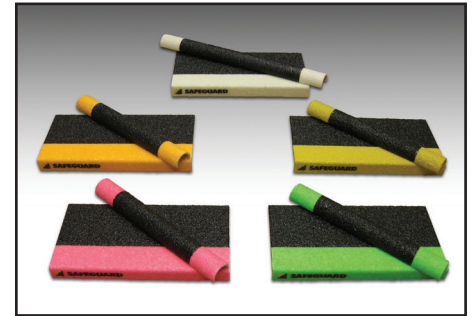
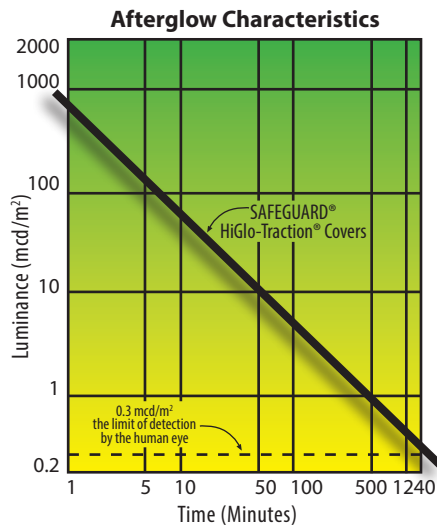

HiGlo-Traction® Color Options

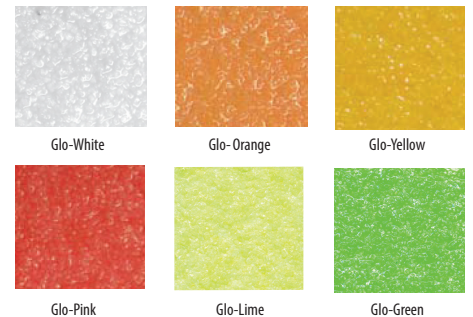

HiGlo-Traction®

SAFEGUARD® HiGlo-Traction® Covers glow in the dark, producing a light source that can provide critical egress when the lights go out. These products incorporate a photoluminescent pigment directly into the Anti-Slip system. Unlike paints, the pigment will not wear off and will last for the life of the Cover.

Coverage and Configuration

Choose full 100% photoluminescent or for an economical alternative, combine with Hi-Traction® colors for a two-tone configuration; calling attention to the leading edge of a step or edges of a walkway or ladder rung. Customize with directional marking or descriptive messages to point the way to safety.

***NOTE: Safeguard® HiGlo-Traction® Covers must be charged by a light source to activate the photoluminescent "Glow-in-the-Dark" pigment.**

Afterglow

HiGlo-Traction® Covers can be fully charged after 5 minutes of exposure to sunlight, 8 minutes at dusk, or 10 minutes in fluorescent light. Luminance will remain visible to the adjusted eye for 12-20 hours after the light source is removed. The green/yellow glow is created by embedded inorganic photoluminescent pigment that is non-toxic, non-radioactive and can be recharged repeatedly during the life of the product. The Covers exhibit excellent weather and light fastness.

The degree of brightness depends on:

1. Strength and nature of the light source. The higher the UV output the better.

Daylight	excellent
Fluorescent	excellent
Incandescent	fair
Red light	no activation
Sodium vapor	no activation

2. Distance from the light source.

Coefficient of Friction Values

Our HiGlo-Traction® Covers have the same quality and sure-footing surface as our Hi-Traction® line, which set the industry standard for Anti-Slip protection. The Coefficient of Friction value exceeds OSHA & ADA standards when wet, oily or dusty, as measured by the Mark II Model of the Brungraber Slip-Tester.

Physical Properties

Please refer to our General Properties Insert for complete physical properties.

FAQ:

1. Is there a difference between Hi-Traction® and HiGlo-Traction® Anti-Slip capabilities?
No, slip prevention properties and coefficient of friction are identical.
2. Do I have to order 100% photoluminescent Covers?
No, all of our Covers are available in a two-tone configuration with photoluminescent nosing or edging.
3. Are all Safeguard® Hi-Traction® Covers available in photoluminescent?
Yes.

Contact Safeguard Technology for more information or a free sample today.



SAFEGUARD TECHNOLOGY INC.

330.995.5200 | 800.989.1695 Toll-Free in the U.S. and Canada
Email: info@safeguard-technology.com
www.safeguard-technology.com

© Copyright 2016 SAFEGUARD TECHNOLOGY INC.
SAFEGUARD® Covers, Hi-Traction®, HiGlo-Traction®, and Roll-Traction® are registered trademarks of SAFEGUARD Technology Inc. REV2_122115

Anti-Slip Hi-Traction® DESCRIPTIVE MARKINGS



Descriptive Messaging, Corporate Logos & Safety Symbols imbedded into Safeguard® Hi-Traction® Covers

Make a statement, point the way to an emergency escape route or display your company's logo while eliminating the risks of slips and falls.



Anti-Slip Hi-Traction® DESCRIPTIVE MARKINGS

SAFEGUARD Descriptive Markings Your message imbedded in an Anti-Slip Cover!

Descriptive Messaging and Logos

Safeguard was the first to incorporate PPE Safety Messaging on our complete line of Hi-Traction® Covers. Reinforce safety with universally recognized symbols, thus eliminating language barriers. Safeguard also applies corporate logos to enhance branding and reaffirm safety compliance programs.



Applications. Our Descriptive Marking Covers are used in commercial buildings, transportation steps, ramps, lifts, and railway platforms in addition to offshore oil platforms and industrial applications. The descriptive marking is imbedded and sealed into our Hi-Traction® and HiGlo-Traction® Covers and is designed to wear for the life of the product.

Safety in the Dark

By incorporating the photoluminescent option into our Descriptive Marking Covers, you can achieve an extra measure of safety after dark or during power outages.



Glow-in-the-dark Step Cover daytime and at night

Physical Properties

Please refer to our General Properties Insert for complete physical properties.

Cleaning and Installation

Please refer to our Cleaning and Installation insert for complete details.



Questions & Answers:

1. *Can I customize the wording and colors?*
Yes, we can use your text and/or match the color and style of your logo..
2. *Is Descriptive Marking available on all of your safety covers?*
Yes.
3. *Is there a size restriction?*
Yes, the size of the image should be proportional to the size of the Cover.

Contact Safeguard Technology for more information or a free sample today.



SAFEGUARD TECHNOLOGY INC.

330.995.5200 | 800.989.1695 Toll-Free in the U.S. and Canada
Email: info@safeguard-technology.com
www.safeguard-technology.com

© Copyright 2016 SAFEGUARD TECHNOLOGY INC.
SAFEGUARD® Covers, Hi-Traction®, HiGlo-Traction®, and Roll-Traction® are registered trademarks of SAFEGUARD Technology Inc. REV2_122115

Anti-Slip Hi-Traction® INSTALLATION & CLEANING

SAFEGUARD
TECHNOLOGY
Leading Manufacturer of Anti-Slip Safety Products



Anti-Slip Protection with Little to Zero Down Time.

SAFEGUARD® Hi-Traction® Covers are installed over existing steps, walkways and ladder rungs using mechanical fasteners, urethane adhesive, PSA (pressure sensitive adhesive) or tack-welding.



www.safeguard-technology.com

Step Covers | Walkway Covers | Ladder Rung Covers | Pipe & Cable Covers | Roll-Traction® | Anti-Slip Mats | Anti-Slip Tapes

Anti-Slip Hi-Traction® INSTALLATION & CLEANING

SAFEGUARD® Hi-Traction® Covers Easy retrofit installation and cleaning guide

Installation

SAFEGUARD® Covers are pre-fabricated for quick and easy installation over existing substrates including Concrete, Metal, Fiberglass, Steel & Composite Grating, Wood, and Tile. Depending on the base material of construction and surface to be covered, mechanical fasteners, urethane adhesive, PSA (pressure sensitive adhesive) and tack-welding can be used. Pre-drilled holes are available to aid in the installation process. Our Safety Covers are non-load bearing.

Refer to Safeguard Technology's detailed Installation Guide and Diagrams for step-by-step instruction.

Quick Reference Installation Guide

Safeguard Product	Mechanical Fasteners	Adhesive	PSA (Pressure Sensitive Adhesive)	Tack-Welding
Pultruded FRP Step Covers & Walkway Covers	X	X		
1mm FRP Walkway Covers	X	X	X	
* Weld-Tab Walkway Covers are available for tack-welding				X
Pultruded FRP Ladder Rung Covers	X (Hollow rungs only)	X		
Stainless & Galvanized Steel Step & Walkway Covers	X	X		X
Stainless & Galvanized Steel Ladder Rung Covers				X
Flexible PVC Vinyl Walkway Covers		X	X	
Fiberglass Pipe & Cable Covers	X	X		
Roll-Traction® - Geomembrane	X	X		

Cleaning

Regular cleaning will keep your Hi-Traction® Covers free of debris and looking new. Most household or industrial methods can be used. Detergents and mild degreasers work well. For stubborn deposits, use a stiff bristle brush. High pressure heated water (as used in food processing plants) may be used in industrial environments.

CAUTION: Do not use mops. The gritted surface will catch and retain fibers. Solvents are not generally recommended. If necessary, mild solvents may be used provided they are diluted and immediately hosed off with water.



Example showing before and after pressure washing

Snow and Ice Removal

1. Brooms will remove loose snow.
2. Plastic shovels are suitable for top layers of heavy snow accumulation. Do not use metal shovels, scrapers, or wire brushes.
3. Use salt, calcium chloride or other melting agents on compacted snow and ice.

Top Coat

If you choose to apply a top coat of paint to revitalize the color after years of wear, only apply a thin coating of alkyd silicone enamel. A heavy application will diminish the effectiveness of the grit surface, and reduce coefficient of friction values.

Contact Safeguard Technology for more information or a free sample today.



SAFEGUARD TECHNOLOGY INC.
330.995.5200 | 800.989.1695 Toll-Free in the U.S. and Canada
Email: info@safeguard-technology.com
www.safeguard-technology.com
© Copyright 2016 SAFEGUARD TECHNOLOGY INC.
SAFEGUARD® Covers, Hi-Traction®, HiGlo-Traction®, and Roll-Traction® are registered trademarks of SAFEGUARD Technology Inc. REV2_122115

Anti-Slip Hi-Traction® INSTALLATION DIAGRAMS

For Safeguard Step Covers

Step Cover Installation with Mechanical Fasteners

(See back for adhesive instructions)

Step Cover Installation Over Grating

Install utilizing Universal Saddle Clip Assemblies with Slotted Truss Head Bolt, Nut and Lock Washer (All Stainless Steel)

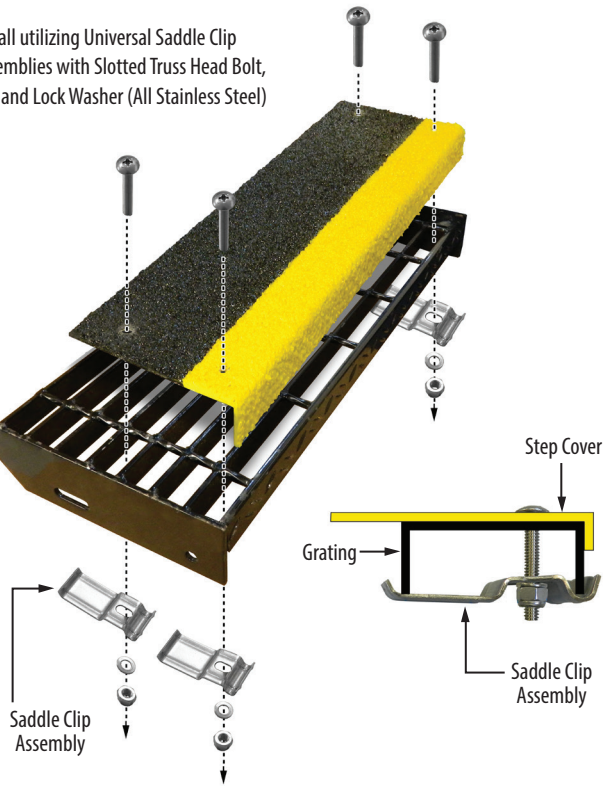

Step Cover Installation Over Diamond/Checker Plate

Install utilizing Self-Tapping or Self-Drilling (Tek) Screws or Rivets and Low Profile Head, Nuts and Bolts. (Depending on your particular application)

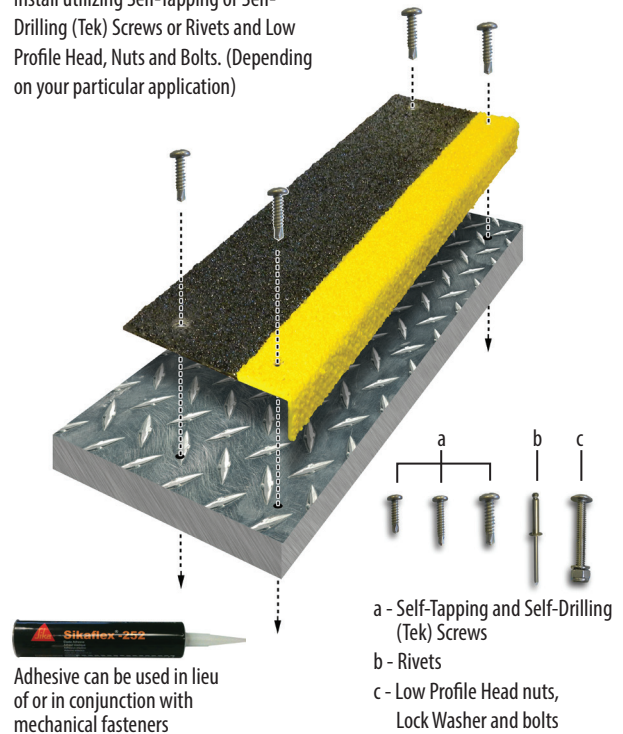

Step Cover Installation Over Concrete

Install using screws and masonry fasteners.

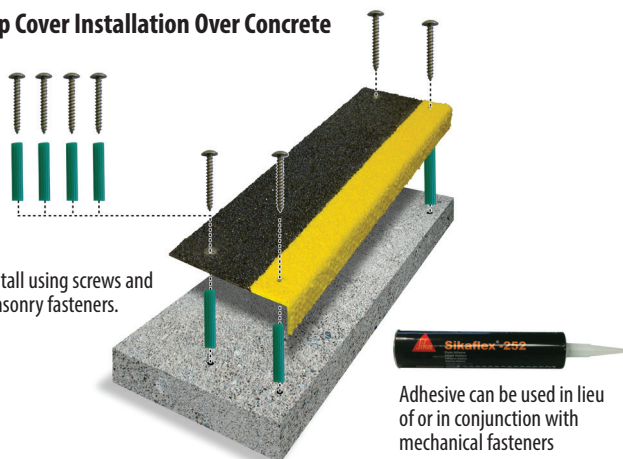

Step Cover Installation Over Wood

Install using 1 1/2" standard type screws

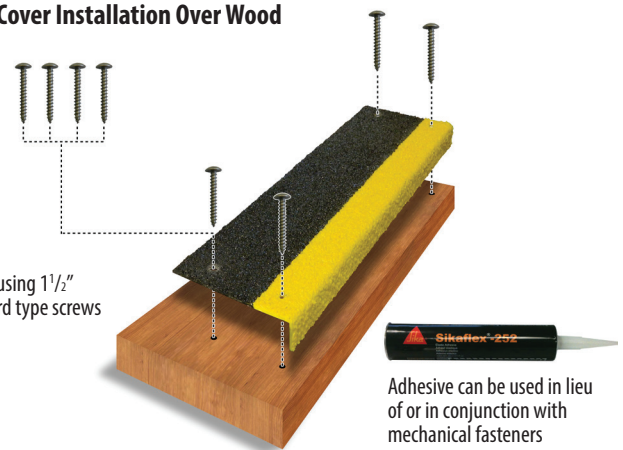

Please refer to the Installation guidelines literature for detailed "step-by-step" written instructions.

NOTE: Please reference red "Attention" instructions on back of this page for air tool usage and instructions.

Safeguard recommends placing mechanical fasteners 1" x 1" in each corner of your Anti-Slip Cover with spacing 10" to 14" between each fastener.

* The number of Saddle Clip Assemblies is directly influenced by the condition of the grating to be covered. New and good condition 1' grating may not require as many Saddle Clip Assemblies.

† Good condition is considered flat/level and non-corroded. Contact Safeguard to discuss your application.

Anti-Slip Hi-Traction® INSTALLATION DIAGRAMS

For Safeguard Step Covers

Step Cover Installation using adhesive

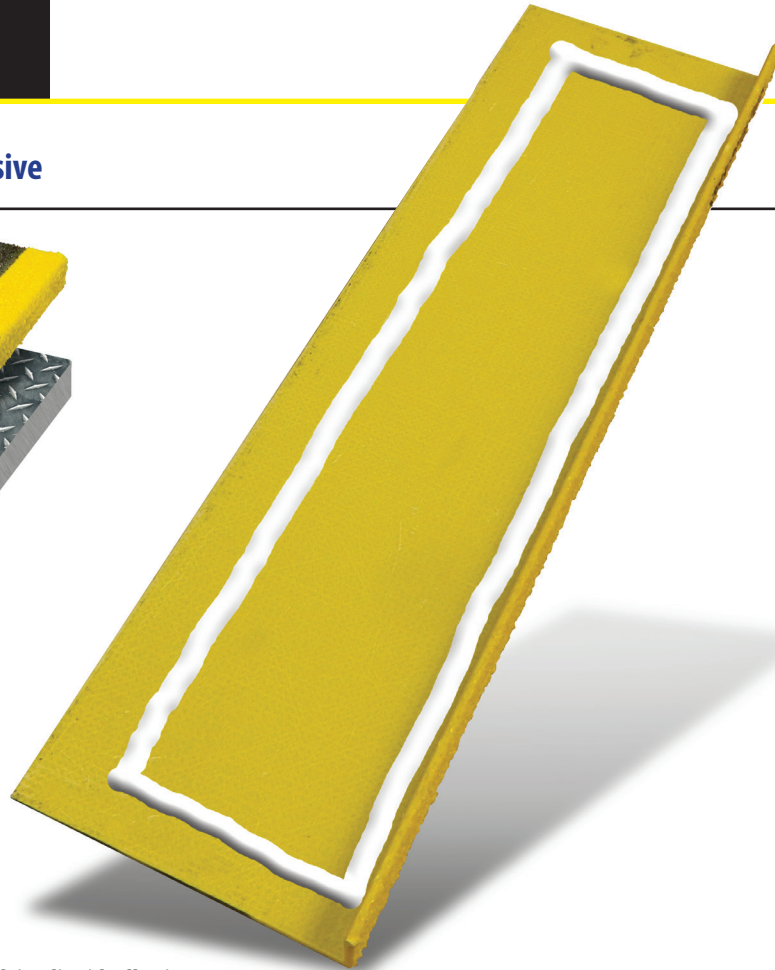
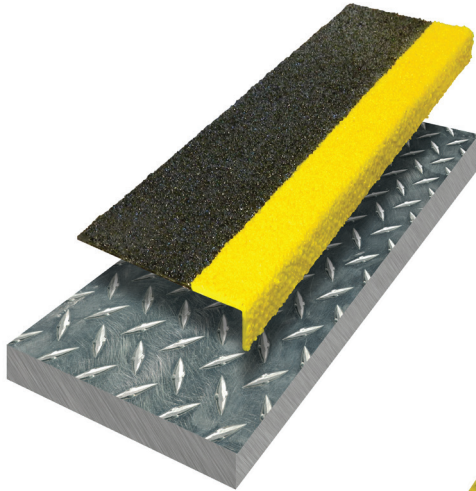

Red indicates pattern to follow when applying liquid adhesive.



3" - 9" Step Cover

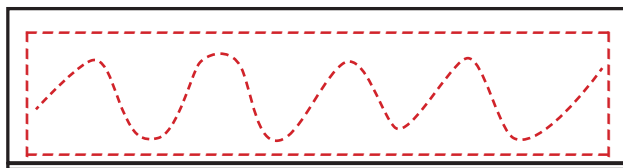

>9" - Step Cover

Minimum adhesive usage shown.

Depending on condition of substrate more can be applied, or troweled.

When using liquid adhesive, please refer to detailed installation and surface preparation instructions. Follow the pattern to the left for maximum adhesion when installing over diamond plate, concrete, and wood.



ATTENTION:

Reduce the speed of your pneumatic air tools to prevent thread galling and bolt snapping while installing saddle clips.

We recommend using a #2 Phillips screwdriver or adaptor when installing to avoid head stripping.

The use of a thread lubricant is also recommended to reduce heat and assist in a smooth installation of this product.

Contact Safeguard Technology for more information or a free sample today.



SAFEGUARD TECHNOLOGY INC.
330.995.5200 | 800.989.1695 Toll-Free in the U.S. and Canada
Email: info@safeguard-technology.com
www.safeguard-technology.com

© Copyright 2016 SAFEGUARD TECHNOLOGY INC.
SAFEGUARD® Covers, Hi-Traction®, HiGlo-Traction®, and Roll-Traction® are registered trademarks of SAFEGUARD Technology Inc. REV2_122115



Walkway Cover Installation with Mechanical Fasteners

(See back for adhesive instructions)

Walkway Cover Installation Over Grating

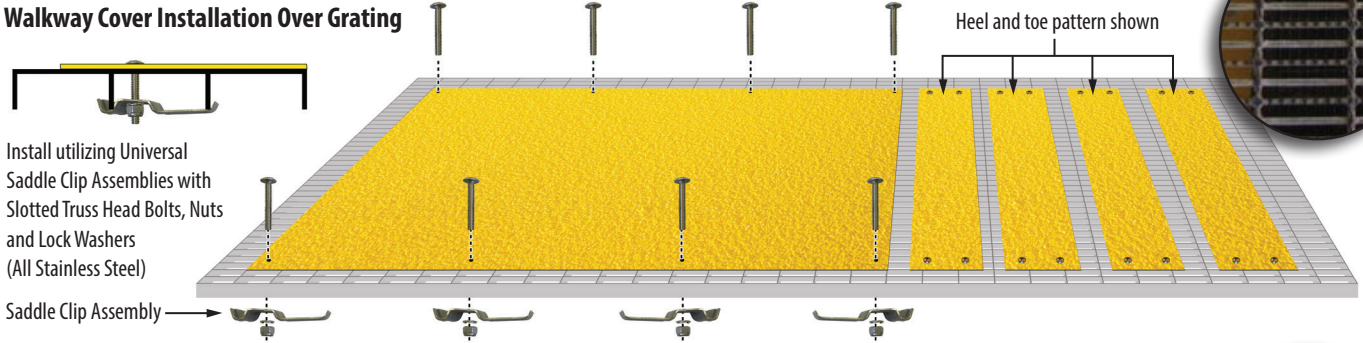

Walkway Cover Installation Over Diamond/Checker Plate

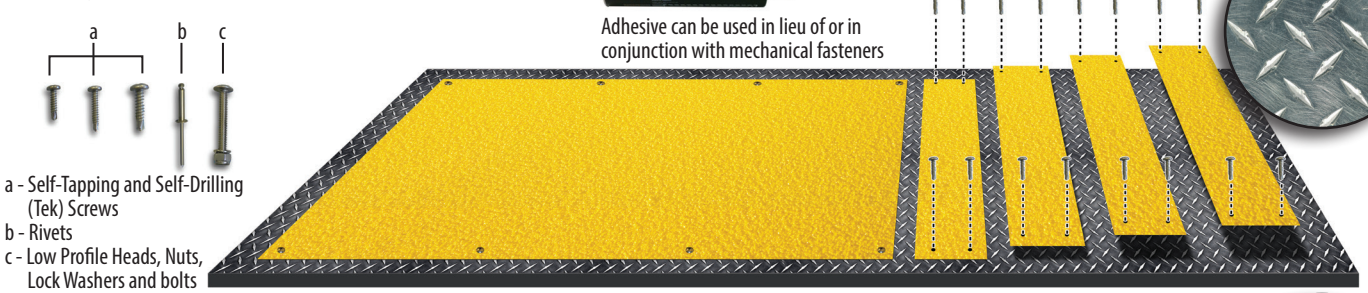

Walkway Cover Installation Over Concrete

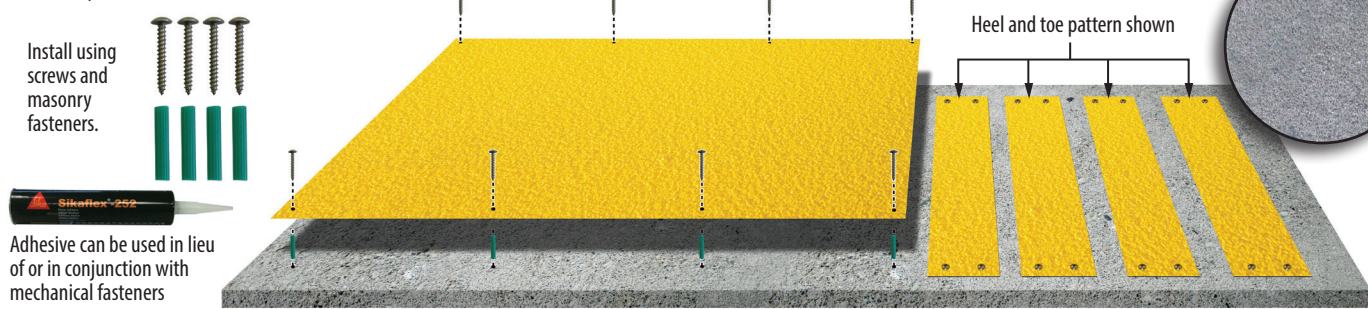

Walkway Cover Installation Over Wood

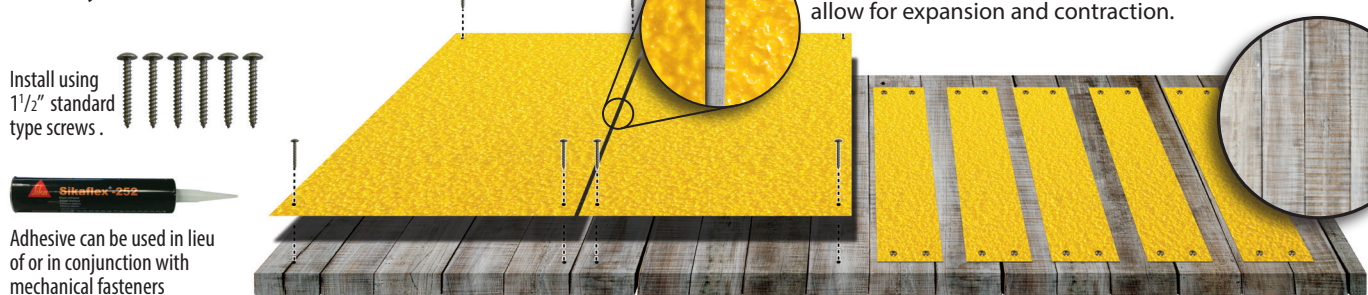

Please refer to the Installation Guidelines literature for detailed "step-by-step" written instructions.

NOTE: Please reference red "Attention" instructions on back of this page for air tool usage and instructions.

Safeguard recommends placing mechanical fasteners 1" x 1" in each corner of your Anti-Slip Cover with spacing 10" to 14" between each fastener.

* The number of Saddle Clip Assemblies is directly influenced by the condition of the grating to be covered. New and good condition¹ grating may not require as many Saddle Clip Assemblies.

¹Good condition is considered flat/level and non-corroded. Contact Safeguard to discuss your application.



INSTALLATION DIAGRAMS

For Walkway Covers & PSA Material

Walkway Cover Installation using adhesive

Minimum adhesive usage shown.
Depending on condition of substrate,
more can be applied or troweled.

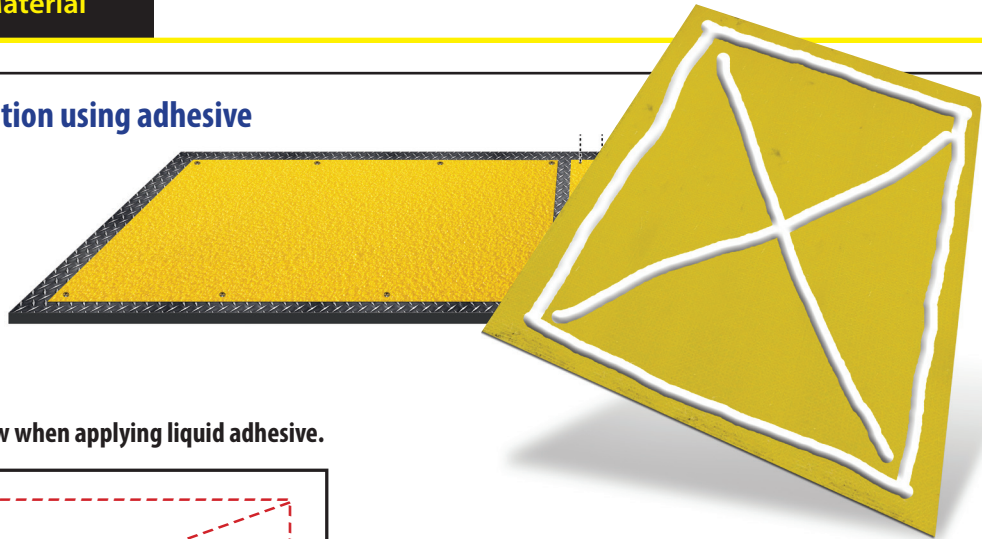

Red indicates pattern to follow when applying liquid adhesive.

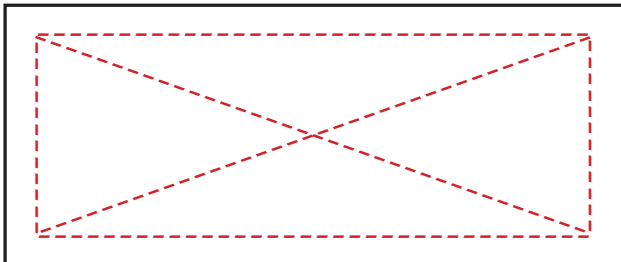

When using liquid adhesive, please refer to detailed installation and surface preparation instructions. Follow the pattern to the left for maximum adhesion when installing over diamond plate, concrete, and wood.

Installation using Pressure Sensitive Adhesive (PSA)



Vinyl Walkway Cover with PSA

Peel and release liner backing, then press firmly into place.

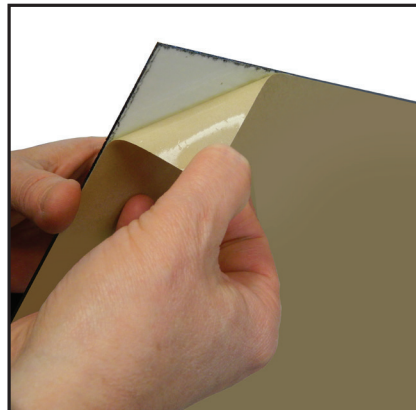

1mm Fiberglass FRP with PSA



SAFEGUARD TECHNOLOGY INC.

330.995.5200 | 800.989.1695 Toll-Free in the U.S. and Canada

Email: info@safeguard-technology.com

www.safeguard-technology.com

© Copyright 2016 SAFEGUARD TECHNOLOGY INC.
SAFEGUARD® Covers, Hi-Traction®, HiGlo-Traction®, and
Roll-Traction® are registered trademarks of SAFEGUARD
Technology Inc. REV2_122115

Anti-Slip Hi-Traction® INSTALLATION DIAGRAMS

For Safeguard® Ladder Rung Covers

Ladder Rung Cover Installation using Adhesive (See reverse side for Tack Welding or Screws)

Stainless and
Galvanized Steel

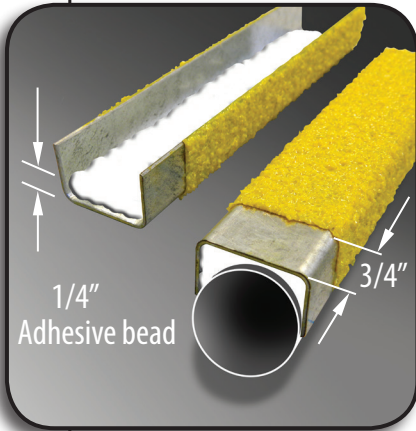

FRP
Half Round



FRP Channel

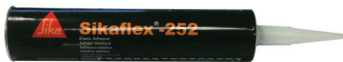

Safeguard carries the Sika line of adhesives. Sikaflex®-252 is a 1-component, moisture cured, polyurethane adhesive with extremely high thixotropy and high strength.

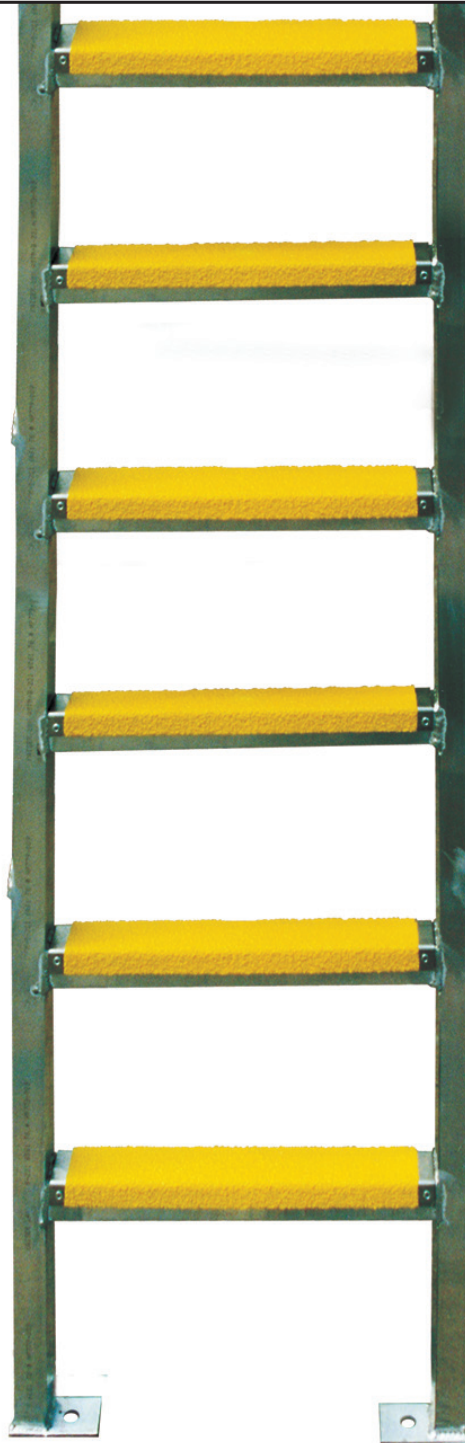

Anti-Slip Hi-Traction®

INSTALLATION DIAGRAMS

For Safeguard® Ladder Rung Covers

Ladder Rung Cover Installation using Tack Welding or Screws

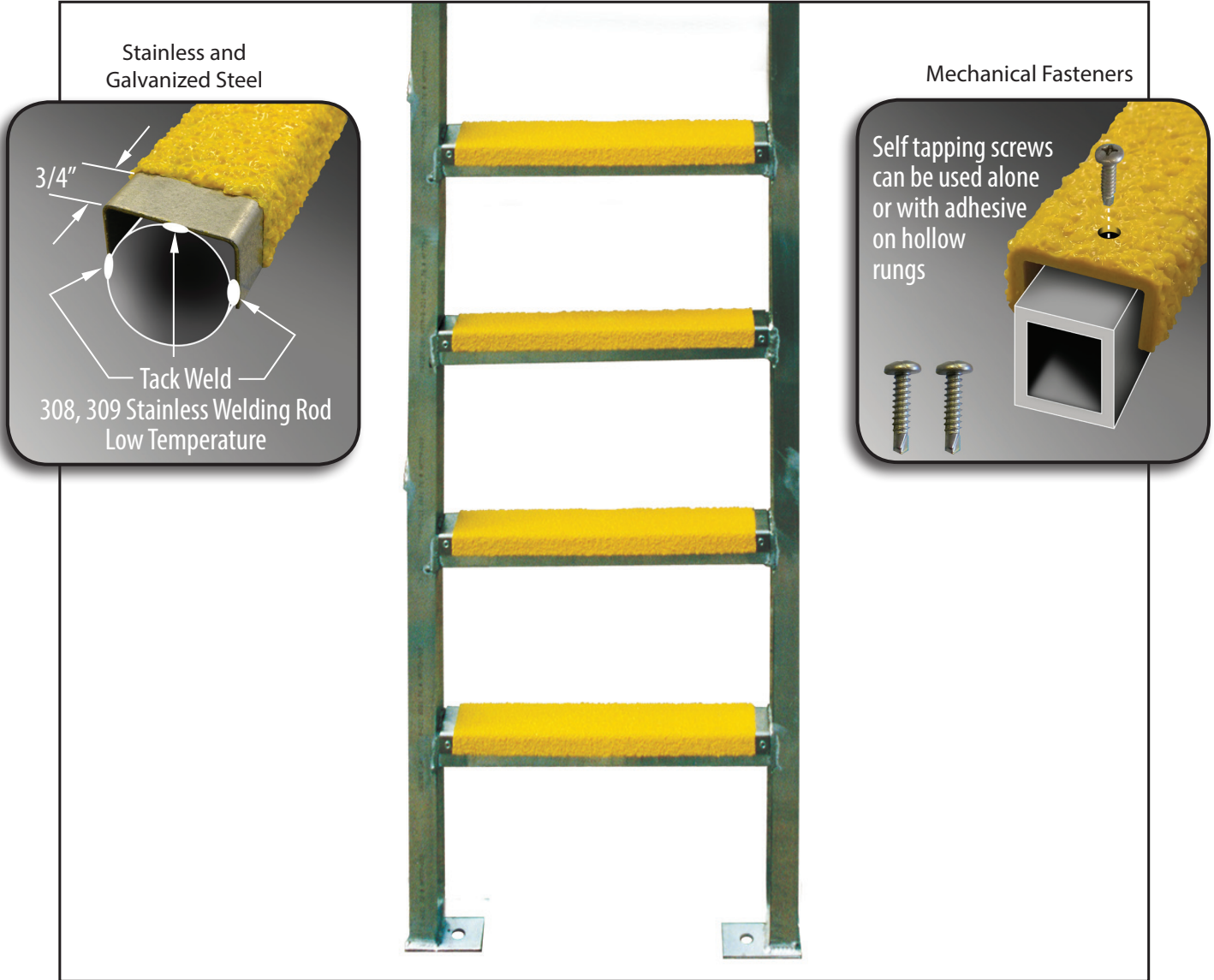

ATTENTION:



Reduce the speed of your pneumatic air tools to prevent thread galling and bolt snapping while installing saddle clips.

We recommend using a #2 Phillips screwdriver or adaptor when installing to avoid head stripping.

The use of a thread lubricant is also recommended to reduce heat and assist in a smooth installation of this product.

SAFEGUARD TECHNOLOGY
Leading Manufacturer of Anti-Slip Safety Products

SAFEGUARD TECHNOLOGY INC.

330.995.5200 | 800.989.1695 Toll-Free in the U.S. and Canada

Email: info@safeguard-technology.com

www.safeguard-technology.com

© Copyright 2016 SAFEGUARD TECHNOLOGY INC.
SAFEGUARD® Covers, Hi-Traction®, HiGlo-Traction®, and Roll-Traction® are registered trademarks of SAFEGUARD Technology Inc. REV2_122115

What is needed for Installation:

Mechanical fasteners:

- Appropriate PPE - Safety glasses, gloves, dust mask and hearing protection are suggested.
- Broom and dust pan or ShopVac.
- Tape Measure or Ruler.
- Marking utensil or Sharpie™.
- Shop Cloth.
- Variable Speed Drill with the appropriate sized bit
TiAIN (titanium aluminum nitride) drill bits are recommended especially for stainless steel. Alternatively, solid carbide drills designed specifically for stainless applications could be used.
- All fasteners (Screws) should feature low profile heads, such as Truss Heads or Pan Heads supplied by Safeguard.
- Socket wrench (for use with Saddle Clip Assemblies over Grating).

Adhesive:

- Appropriate PPE - Safety Glasses, gloves, and dust mask are suggested.
- Broom and dust pan or ShopVac.
- Tape Measure or Ruler.
- Light grade sandpaper and/or Scotch-Brite Pad (or similar).
- Denatured alcohol or acetone.
- Standard caulking gun used to apply adhesive.
- Nail to puncture seal of adhesive cartridge.
- Paint Scraper.
- Depending on the condition of the surface. Power washer, primer and grinder may be necessary.

SURFACE PREPARATION

Prior to installing your SAFEGUARD® Antislip Cover, surface preparation is necessary. The extent depends on the condition of the surface (substrate) you are covering, as well as the installation process you intend to use.

MECHANICAL FASTENERS:

In most cases, simply sweeping the surface and removing loose debris is sufficient. Here are some exceptions:

- Raised/Uneven Surfaces – Depending on the severity (more than 1/8”), leveling compound may be needed. Uneven surfaces can make fastening difficult (adhesive impossible) and can cause damage to the Cover over time.
- Chipped Concrete (particularly on leading edge of steps) – Old and damaged concrete that is chipping away requires leveling compound. SAFEGUARD® Covers are not load-bearing and must be fully supported. Gaps under the Cover or unsupported areas will result in damage to the (FRP) fiberglass Cover.
- Steel – Remove existing screw heads

CUTTING YOUR SAFEGUARD ANTISLIP COVER

All SAFEGUARD® Covers are cut and fabricated to customer specification. Should additional field cutting be necessary, Safeguard suggests using a diamond blade with appropriate PPE.

RECOMMENDED MECHANICAL FASTENERS

All fasteners should feature low profile heads, such as Truss Head or Pan Head screws supplied by Safeguard.

CONCRETE:.....Masonry Fasteners with Plastic Insert Sleeve Tapcon®

STEEL:.....Self-Tapping 1” or 1-1/2” Truss Head Screws
Self-Drilling 3/4” or 1” TEK – Pan Head Screws

WOOD:.....Self-Tapping 1” or 1-1/2” Truss Head Screws

NOTE: Wood Screws with small profile heads (same diameter as body) are not recommended

STEEL/FIBERGLASS GRATING: Universal Saddle Clip Assembly

* If installing SAFEGUARD® Covers over Grip-Strut or grating with a raised surface set back from the leading edge, we recommend a “Backer Plate” under the nosing to fill in this area and support the Cover. This is available by request.

DRILLING FASTENER HOLES:

Safeguard can pre-drill holes in your Antislip Cover to assist in fastening. If you choose to drill the Covers in the field, below is a chart with the recommended drill bit sizes for the corresponding screws. In addition to pre-drilled holes in your SAFEGUARD® Cover, pilot holes in the substrate can be helpful during installation.

Screw/Bolt Size	Drill bit size required
#8 x 1” Screw	7/32” diameter drill bit
#10 x 1-1/2” Screw	9/32” diameter drill bit
1/4” Bolt	3/8” diameter drill bit

Drill Bits: TiAIN (titanium aluminum nitride) drill bits are recommended, especially for stainless steel. Alternatively, solid carbide drills designed specifically for stainless applications could be used.

Countersinking: Due to the low profile of the Safeguard Covers, countersunk holes are limited to the 1/8” Pultruded FRP (Fiberglass) base construction products. It is recommended that countersunk holes are specified prior to manufacturing.

Anti-Slip Hi-Traction® COVERS Installation Guidelines

Section 1 of 3

PILOT HOLE DEPTH:

CONCRETE:..... Drill to the depth of the plastic Sleeve used with the masonry fastener.

NOTE: If using Tapcon®, follow the manufacturer's recommended instructions.

STEEL:..... Drill all the way through the steel or as deep as possible.

WOOD:..... Not necessary. If preferred, drill just to the depth of the screw being used.

STEEL/FIBERGLASS GRATING:.....N/A

OUTDOOR APPLICATIONS & EXPANSION/CONTRACTION:

To compensate for expansion/contraction over outdoor substrates (wood, concrete etc), use 1/8" larger drill bit than size recommended on the chart when drilling holes in your Safeguard® Cover. It is also important to leave a small space between Walkway Covers when assembling a series end to end. A space of approximately 1/8 inch is recommended between sheets.

ADHESIVE & PSA (Peel & Stick "Pressure Sensitive Adhesive"):

When using an adhesive, all surfaces must be clean, dry, and dust-free. If the surface has a pre-existing coating, it must be fully bonded to the substrate. If there is peeling or possible delamination, all existing coatings or paints must be removed until the bare substrate is exposed. This may require scraping, grinding or sand blasting.

NOTE: If a SAFEGUARD® Cover is adhered to an unstable surface, or one that delaminates from the substrate, the Cover will come off as well.

Once the substrate is clean of loose debris, rust, or coatings, the surface can be wiped with acetone or de-natured alcohol. This will help to eliminate oils* and grease that may inhibit the bond.

Finally, the substrate can be lightly abraded using a Scotch-Brite™ pad or similar type until the surface shine is dulled.

* Surfaces that are exposed to grease or oil may require a degreasing agent or primer. If the substrate is extremely saturated, mechanical fasteners are strongly recommended or a combination of adhesive and mechanical fasteners.

Applying Ladder Rung Covers to Carbon Steel:

1. Thoroughly clean steel rungs to remove any dirt, oil, grease, etc.
2. Abrade to remove any rust.
3. Apply a metal primer followed by high quality industrial coating which does not contain silicone or Teflon.
4. When the topcoat is dry or cured, scuff lightly with sandpaper to remove gloss.
5. Adhesive such as Sikaflex 252 can now be applied.

RECOMMENDED ADHESIVE:

Safeguard carries the Sika line of adhesives. Sikaflex®-252 is a 1-component, moisture cured, polyurethane adhesive with extremely high thixotropy and high strength.



- Bonds and seals at the same time
- One part formulation
- Replaces rivets and mechanical fasteners
- Very high thixotropy for good gap filling properties
- Adhesion to a wide range of substrates
- Short tack free and curing time
- Non-staining curing process
- Initial load-bearing capacity
- Sandable and paintable
- Increases torsional stiffness of final assembly
- Shock/impact resistant
- Vibration and sound damping
- Excellent weather and water resistance
- USDA approved for incidental food contact



Leading Manufacturer of Anti-Slip Safety Products

SAFEGUARD TECHNOLOGY INC.

330.995.5200 | 800.989.1695 Toll-Free in the U.S. and Canada

Email: info@safeguard-technology.com

www.safeguard-technology.com

© Copyright 2016 SAFEGUARD TECHNOLOGY INC.
SAFEGUARD® Covers, Hi-Traction®, HiGlo-Traction®, and Roll-Traction® are registered trademarks of SAFEGUARD Technology Inc. REV2_122115

INSTALLING YOUR SAFEGUARD ANTISLIP COVER WITH MECHANICAL FASTENERS

STEP COVERS OVER WOOD, STEEL & CONCRETE:

To compensate for expansion/contraction over outdoor substrates (wood, concrete etc), use 1/8" larger drill bit than recommended on the chart when drilling holes in your Safeguard® Cover.

1. Prior to drilling, determine placement of Covers (usually centered on the step). It is recommended to start with the top step and work down.
2. SAFEGUARD® Covers are available with pre-drilled holes. If your Covers have **pre-drilled holes, skip to STEP #8.**
3. Measure from the left stringer and note distance to ensure a consistent alignment of all Step Covers within the stairwell. If you are not covering the entire step, measure from the closest stringer.
4. If your Step Covers do not have pre-drilled holes, position one Step Cover over the substrate and determine the desired location for the screws. There may be impediments that determine where the holes should be drilled: i.e. on wood, there may be spacing between boards.
5. Slide the Step Cover back towards the riser (or rear of step) until the vertical lip hits flush on the leading edge of the step. It is imperative that the leading edge of the Step Cover be fully supported or damage will incur, including cracking of the FRP Cover.
6. Once the position of the drill holes is determined, mark the underside of the Cover with a shop pencil or Sharpie™. Safeguard recommends that pre-drilled holes be at least 1" (25 mm) in from the edge of the Covers to avoid fracturing (FRP).
7. Place Step Cover so that the bottom side is facing up. Always drill from the underside through to the gritted surface. We suggest using a wood plank underneath for support during the drilling operation. Using the appropriate sized drill bit from the **Drill Bit Chart** (Section 1), pre-drill the holes into the underside of your SAFEGUARD® Cover using the markings you created.
8. You can choose to use this Cover as a template for the entire stairwell when marking pilot hole location. If installing your cover over wood, pilot holes are not necessary. **SKIP TO STEP # 15.**
9. Re-align your Step Cover on the step with the pre-drilled holes in the precise position you want the Cover installed.
10. Pilot Holes - Place a marking device Sharpie™ in the pre-drilled hole and mark the substrate accordingly.
11. Remove the Step Cover.
12. Drill the pilot holes into the marked area on the substrate to the appropriate depth indicated in the **"PILOT HOLE DEPTH"** guide (Section 1).
13. Using a brush, broom, or ShopVac™, remove the dust and debris caused by the drilling.
14. When using masonry fasteners, once the surface is clear of dust and debris, insert the plastic sleeve into the pilot hole. The top of the insert sleeve should sit flush with the top of the pilot hole.
15. Place the Step Cover over the step taking care to align the pre-drilled holes precisely with the pilot holes. If installing over wood or lack of pilot holes, simply place the Cover in the preferred location on the step.
16. Insert the appropriate screw and Torque¹ until a tight fit/seal is achieved.

¹ Please reference the red "Attention" square on the back of this page for torque recommendations

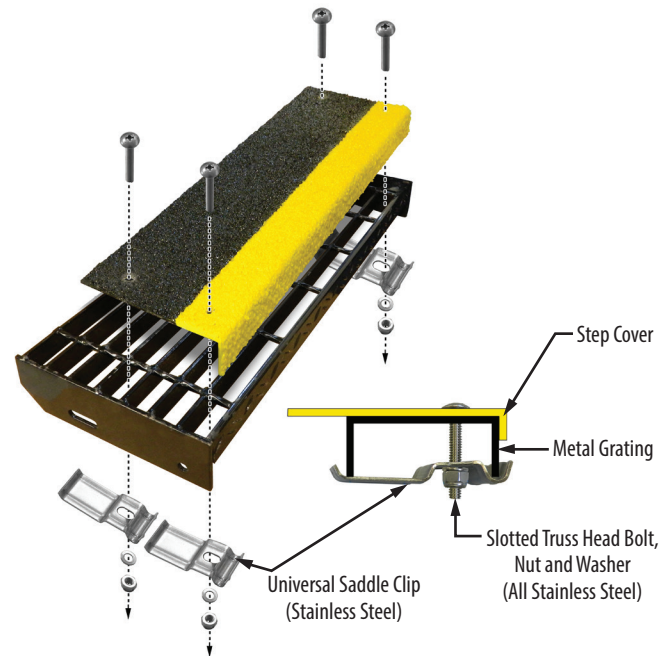

STEP COVERS OVER GRATING:

1. Check all steps to determine if grating location is consistently positioned. If steps have been fabricated with the same grating configuration, a template can be used to locate drill holes.
2. Place Step Cover in position on the step. It is recommended to start with the top step and work down.
3. Mark drill hole positions on the bottom side of the Step Cover. Drill holes should be centrally located between grating bars. Hole positions should be at least 1" (25 mm) from the edges of the Step Cover.
4. Measure drill hole locations from the sides and back edges of the Step Cover. Use these measurements to mark the bottom side of other Step Covers being installed at that location or on the template.
5. Place Step Cover so that the bottom side is facing up. Always drill from the underside through to the gritted surface. We suggest using a wood plank underneath for support during the drilling operation.
6. Using the appropriate sized drill bit from the **Drill Bit Chart** (Section 1), pre-drill the holes into the underside of your SAFEGUARD® Cover using the markings you created.
7. Position Step Cover on the step. Insert bolts into Step Cover.
8. From underneath the step, place the saddle clip, lock washer and then the lock nut on the bolts.
9. Use the socket wrench to hold the locknut under the step.
10. Insert the driver in the bolt head. Slowly tighten the bolt and make sure the saddle clip remains properly positioned on the grating bars.
11. **Warning – Do Not Over Torque!**
12. Securely fasten remaining saddle clip assemblies and ensure Step Cover is properly installed.

Anti-Slip Hi-Traction® COVERS Installation Guidelines

Section 2 of 3

WALKWAY COVERS OVER WOOD, STEEL & CONCRETE:

NOTE: To compensate for expansion/contraction over outdoor substrates (wood, concrete etc), use 1/8" larger drill bit than size recommended on the chart when drilling holes in your Safeguard® Cover. It is also important to leave a small space between Walkway Covers when assembling a series end to end. A space of approximately 1/4 inch should be left between sheets.

1. Prior to drilling, determine placement of Cover on walkway or landing.
2. SAFEGUARD® Covers are available with pre-drilled holes. **If your Covers have pre-drilled holes, skip to STEP # 8.**
3. If your Walkway Cover does not have pre-drilled holes, position one Cover over the substrate and determine the desired location for the screws. There may be impediments that determine where the holes should be drilled: i.e. on wood, there may be spacing between boards.
4. Once the position of the drill holes is determined, mark the underside of the Cover with a shop pencil or Sharpie™. Safeguard recommends that pre-drilled holes be at least 1" (25 mm) in from the edge of the Covers to avoid fracturing (FRP).
5. Place Walkway Cover so that the bottom side is facing up. Always drill from the underside through to the gritted surface. We suggest using a wood plank underneath for support during the drilling operation.
6. Using the appropriate sized drill bit from the Drill Bit Chart (Section 1), pre-drill the holes into the underside of your SAFEGUARD® Cover using the markings you created.
7. Re-align your Cover with the pre-drilled holes in the precise position you want the Cover installed.
8. (Pilot Holes) - Place a marking device in the predrilled holes and mark the substrate accordingly. **If installing your Cover over wood, pilot holes are not necessary. SKIP TO STEP # 13.**
9. Remove the Walkway Cover.
10. Drill the pilot holes to the appropriate depth indicated in the **PILOT HOLE DEPTH** guide (Section 1).
11. Using a brush, broom, or ShopVac™, remove the dust and debris caused by the drilling.
12. If using masonry fasteners, once the surface is clear of dust and debris, insert the plastic sleeve into the pilot hole. The top of the insert sleeve should sit flush with the top of the pilot hole.
13. Place the Walkway Cover over the area taking care to align the pre-drilled holes precisely with the pilot holes. If installing over wood or there are no pilot holes, simply align the Cover in the desired location.
14. Insert the appropriate screw and Torque¹ until a tight fit/seal is achieved.

WALKWAY COVERS OVER GRATING:

1. Prior to drilling, determine placement of Cover on walkway or landing.
2. Mark drill hole positions on the bottom side of the Walkway Cover. Drill holes should be centrally located between grating bars. Hole positions should be at least 1" (25 mm) from the edges of the Walkway Cover.
3. Measure drill hole locations from the sides of the Walkway Cover.
4. Place Walkway Cover so that the bottom side is facing up. Always drill from the underside through to the gritted surface. We suggest using a wood plank underneath for support during the drilling operation.
5. Using the appropriate sized drill bit from the Drill Bit Chart (Section 1), pre-drill the holes into the underside of your SAFEGUARD® Cover using the markings you created.
6. Align your Cover with the pre-drilled holes in the precise position you want the Cover installed.

7. Insert bolts into Walkway Cover.
8. From underneath the Walkway or Landing, place the saddle clip, lock washer and then the lock nut on the bolts.
9. Use the socket wrench to hold the locknut under the step.
10. Insert the driver in the bolt head. Slowly tighten the bolt and make sure the saddle clip remains properly positioned on the grating bars.
Warning – Do Not Over Torque!
11. Securely fasten remaining saddle clip assemblies and ensure Walkway Cover is properly installed.

LADDER RUNG COVERS:

Most Ladder Rung Covers are installed using Sikaflex Adhesive however, mechanical fasteners can be used (on large diameter, channel shaped hollow rungs). In the case of Stainless or Galvanized Covers, tack-welding is an option.

PIPE & CABLE COVERS:

1. Prior to drilling, determine placement of Cover.
2. SAFEGUARD® Covers are available with pre-drilled holes. **If your Covers have pre-drilled holes, skip to STEP # 6.**
3. If your Pipe & Cable Cover does not have pre-drilled holes, position the Cover over the substrate, pipe and/or cable and determine the desired location for the screws. Safeguard recommends that pre-drilled holes be at least 1" in from the edge of the Covers to avoid fracturing (Fiberglass).
4. Once the position of the drill holes is determined, mark the underside of the Cover with a Sharpie™.
5. Using the appropriate sized drill bit from the Drill Bit Chart, pre-drill the holes into the underside of your SAFEGUARD® Cover using the markings you created.
6. Re-align your Pipe & Cable Cover with the pre-drilled holes in the precise position you want the Cover installed.
7. (Pilot Holes) - Place a marking device in the pre-drilled hole and mark the substrate accordingly.
8. Remove the Pipe & Cable Cover.
9. Now drill the pilot holes into the marked area on the substrate to the appropriate depth indicated in the (PILOT HOLE DEPTH) instructions.
10. Using a brush, broom, or ShopVac™, remove the dust and debris caused by the drilling.
11. If using masonry fasteners, once the surface is clear of dust and debris, insert the plastic sleeve into the pilot hole. The top of the insert sleeve should sit flush with the top of the pilot hole.
12. Place the Pipe & Cable Cover over the substrate taking care to align the pre-drilled holes precisely with the pilot holes.
13. Insert the appropriate screw and Torque¹ until a tight fit/seal is achieved. **Warning – Do Not Over Torque!**



¹Please reference this red "Attention" square for torque recommendations



SAFEGUARD TECHNOLOGY INC.
330.995.5200 | 800.989.1695 Toll-Free in the U.S. and Canada
Email: info@safeguard-technology.com
www.safeguard-technology.com

© Copyright 2016 SAFEGUARD TECHNOLOGY INC.
SAFEGUARD® Covers, Hi-Traction®, HiGlo-Traction®, and Roll-Traction® are registered trademarks of SAFEGUARD Technology Inc. REV2_122115

INSTALLING YOUR SAFEGUARD ANTISLIP COVER WITH ADHESIVE

Safeguard carries and recommends the Sika line of moisture cured urethane adhesives. Refer to the manufacturer's instructions for cure time relative to the temperature and humidity of your environment. Typically allow 24 hours for the adhesive to cure.

NOTE: Sikaflex 252 is a moisture cured urethane adhesive. The curing process can be accelerated by tamping the substrate with a damp cloth immediately prior to adhering your SAFEGUARD® Cover.

WARNING: Take care to avoid contacting grit surface with adhesive. The adhesive will immediately bond, making removal impossible.

STEP COVERS OVER WOOD, STEEL & CONCRETE:

1. Closely follow the surface preparation instructions for adhesive provided by Safeguard.
2. Determine placement of the Cover (usually centered on the step).
3. Using fine grade sandpaper, lightly abrade the underside of the Cover. This will help in promoting the bond with the adhesive.
4. Insert the cartridge of SikaFlex 252 into a caulking gun and puncture the seal to initiate flow. **Follow instructions on cartridge specifying temperature and cure time.**
5. Apply a 3/4" bead of adhesive to the underside of the cover, around the entire perimeter, 1-2" in from the edges.
6. It is not necessary to apply adhesive to the underside of the vertical lip
7. For Covers exceeding 6" in depth, a  shaped bead is recommended, lengthwise through the middle of the tread.
8. Position the Cover over the surface in the desired position.
9. Firmly push the Cover with adhesive onto the substrate taking care not to slide the Cover.
10. To seal the Cover and prevent water from seeping underneath, run a bead of adhesive around the perimeter where the Cover and substrate meet.

WALKWAY COVERS OVER WOOD, STEEL & CONCRETE:

1. Closely follow the surface preparation instructions for adhesive provided by Safeguard.
2. Determine placement of the Cover.
3. Using fine grade sandpaper, lightly abrade the underside of the Cover. This will help in promoting the bond with the adhesive.
4. Insert the cartridge of SikaFlex 252 into a caulking gun and puncture the seal to initiate flow. **Follow instructions on cartridge specifying temperature and cure time.**
5. Apply a 3/4" bead of adhesive to the underside of the Cover, around the entire perimeter, 1-2" in from the edges.
6. For large covers, an  shaped bead is recommended through the middle of the Cover from corner to corner.
7. Position the Cover over the surface in the desired position.
8. Firmly push the Cover with adhesive onto the substrate taking care not to slide the Cover.
9. To seal the Cover and prevent water from seeping underneath, run a bead of adhesive around the perimeter where the Cover and substrate meet.

LADDER RUNG COVERS Round & Channel Shaped

Adhesive is the only option when installing SAFEGUARD® Pultruded Fiberglass FRP Ladder Rung Covers.

Tack-welding is the most popular method to install steel Ladder Rung Covers, however, if "Hot Work" is not permitted, adhesive is also an option.

1. Closely follow the surface preparation instructions for adhesive provided by Safeguard.
Particular attention is necessary for Carbon Steel.
2. Using fine grade sandpaper, lightly abrade the underside of the cover. This will help in promoting the bond with the adhesive.
3. Insert the cartridge of SikaFlex 252 into a caulking gun and puncture the seal to initiate flow. **Follow instructions on cartridge specifying temperature and cure time.**
4. Start 1" in from one end on the underside of the Cover and apply a 3/4" bead of adhesive the length of the Cover, stopping 1" from the opposite end.
5. Position the Cover over the rung in the desired position.
6. Firmly push the Cover with adhesive onto the rung taking care not to slide the Cover.

INSTALLING YOUR SAFEGUARD ANTISLIP COVER WITH A COMBINATION OF MECHANICAL FASTENERS & ADHESIVE

Using a combination of mechanical fasteners and adhesive ensures a secure installation of your SAFEGUARD® Antislip Cover. SikaFlex adhesive acts as a sealant, preventing water from penetrating the underside of the Covers. In food processing facilities, SikaFlex is USDA accepted to seal the perimeter of your SAFEGUARD® Cover, keeping moisture and bacteria from forming underneath.

STEP COVERS (OVER WOOD, STEEL & CONCRETE):

Follow Steps 1 -14 for Mechanical Fasteners (Step Covers, Section 2)

15. Closely follow the surface preparation instructions for adhesive provided by Safeguard.
16. Determine placement of the Cover.
17. Using fine grade sandpaper, lightly abrade the underside of the Cover. This will help in promoting the bond with the adhesive.
18. Insert the cartridge into the caulking gun and puncture the seal to initiate flow. **Follow manufacturer's instructions on cartridge specifying temperature and cure time.**
19. Apply a 3/4" bead of adhesive (i.e. - Sikaflex 252) to the underside of the cover allowing a 1-2" inch bare edge along the perimeter.
Do not apply adhesive over the pre-drilled holes.
20. For Covers exceeding 6" in depth, a  shaped bead is recommended, lengthwise through the middle of the tread.
21. Position the Step Cover over the step taking care to align the pre-drilled holes precisely with the pilot holes. Firmly push the Cover with adhesive onto the step surface taking care to not slide the Cover or obstruct the drill holes.
22. Insert the appropriate screw and Torque¹ until a tight fit/seal is achieved.
Do not apply adhesive over the pre-drilled holes.
23. To seal the cover, run a bead of adhesive around the entire perimeter at the edge of the substrate.

Anti-Slip Hi-Traction® COVERS Installation Guidelines

Section 3 of 3

WALKWAY COVERS OVER WOOD, STEEL & CONCRETE:

Follow Steps 1 -12 for Mechanical Fasteners (Walkway Covers, Section 2).

13. Closely follow the surface preparation instructions for adhesive provided by Safeguard.
14. Determine placement of Cover.
15. Using fine grade sandpaper, lightly abrade the underside of the Cover. This will help in promoting the bond with the adhesive.
16. Insert the cartridge into the caulking gun and puncture the seal to initiate flow. **Follow instructions on cartridge specifying temperature and cure time.**
17. Apply a 3/4" bead of adhesive (i.e. - Sikaflex 252) to the underside of the Cover allowing a 1-2" inch bare edge along the perimeter. **Do not apply adhesive over the pre-drilled holes.**
18. For large Covers, an  shaped bead is recommended through the middle of the Cover from corner to corner.
19. Position the Walkway Cover taking care to align the pre-drilled holes precisely with the pilot holes. Firmly push the Cover with adhesive onto the surface taking care to not slide the Cover or obstruct the drill holes.
20. Insert the appropriate screw and Torque¹ until a tight fit/seal is achieved.
21. To seal the Cover, run a bead around the entire perimeter at the edge of the substrate.

ATTENTION:



Reduce the speed of your pneumatic air tools to prevent thread galling and bolt snapping while installing saddle clips.

We recommend using a #2 Phillips screwdriver or adaptor when installing to avoid head stripping.

The use of a thread lubricant is also recommended to reduce heat and assist in a smooth installation of this product.

¹ Please reference this red "Attention" square for torque recommendations

INSTALLING YOUR SAFEGUARD ANTISLIP COVER WITH PRESSURE-SENSITIVE ADHESIVE

SAFEGUARD® Flexible PVC Vinyl and 1mm FRP Walkway Covers are available with a PSA (Pressure Sensitive Adhesive) laminate.

1. Closely follow the surface preparation instructions for adhesive provided by Safeguard.
2. SAFEGUARD® Flexible PVC Walkway Covers or 1mm FRP Covers with PSA laminate should be at least 50 degrees Fahrenheit or 10 degrees Celsius before installation.
3. For 1mm FRP: Simply peel back the release liner starting at one corner. Slowly lay the Cover in place, pressing firmly as you go. For improved adhesion, use a weighted roller to complete installation
4. For Flexible Vinyl: Begin by peeling back the release liner on one end, exposing a few inches of the Cover with pressure sensitive adhesive. Carefully position the edge of the material with the edge of the area you plan to cover. Once the Cover is in the correct position, slowly and simultaneously, remove the remainder of the release liner while using your other hand to lightly push the Vinyl Cover into place. Take care to avoid air bubbles under the surface. If one appears, carefully pull the Vinyl Cover up and re-apply.
For improved adhesion, use a weighted roller to complete installation.

CAUTION: Once the Vinyl or 1mm Fiberglass sheet is adhered to the substrate, it is very difficult to adjust.



SAFEGUARD
TECHNOLOGY
Leading Manufacturer of Anti-Slip Safety Products

SAFEGUARD TECHNOLOGY INC.

330.995.5200 | 800.989.1695 Toll-Free in the U.S. and Canada

Email: info@safeguard-technology.com

www.safeguard-technology.com

© Copyright 2016 SAFEGUARD TECHNOLOGY INC.
SAFEGUARD® Covers, Hi-Traction®, HiGlo-Traction®, and Roll-Traction® are registered trademarks of SAFEGUARD Technology Inc. REV2_122115